

## Operating Instructions Functional Manual

LCD Projector Commercial Use

---

Model No. **PT-VW350**  
**PT-VX420**

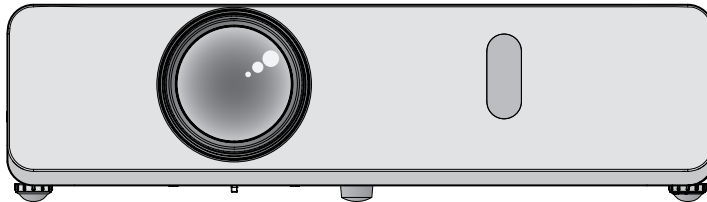

Thank you for purchasing this Panasonic Product.

- Before operating this product, please read the instructions carefully, and save this manual for future use.
- Before using your projector, be sure to read “Read this first!” (➔pages 2 to 8).

# Read this first!

**WARNING:** THIS APPARATUS MUST BE EARTHED.

**WARNING:** To prevent damage which may result in fire or shock hazard, do not expose this appliance to rain or moisture.  
This device is not intended for use in the direct field of view at visual display workplaces. To avoid incommoding reflexions at visual display workplaces this device must not be placed in the direct field of view.  
The equipment is not intended for used at a video workstation in compliance BildscharbV.

The sound pressure level at the operator position is equal or less than 70 dB (A) according to ISO 7779.

**WARNING:**

1. Remove the plug from the mains socket when this unit is not in use for a prolonged period of time.
2. To prevent electric shock, do not remove cover. No user serviceable parts inside. Refer servicing to qualified service personnel.
3. Do not remove the earthing pin on the mains plug. This apparatus is equipped with a three prong earthing type mains plug. This plug will only fit an earthing-type mains socket. This is a safety feature. If you are unable to insert the plug into the mains socket, contact an electrician. Do not defeat the purpose of the earthing plug.

**WARNING:** TO REDUCE THE RISK OF FIRE OR ELECTRIC SHOCK, DO NOT EXPOSE THIS PRODUCT TO RAIN OR MOISTURE.



The lightning flash with arrowhead symbol, within an equilateral triangle, is intended to alert the user to the presence of uninsulated “dangerous voltage” within the product’s enclosure that may be of sufficient magnitude to constitute a risk of electric shock to persons.



The exclamation point within an equilateral triangle is intended to alert the user to the presence of important operating and maintenance (servicing) instructions in the literature accompanying the product.

**WARNING:**



TURN THE POWER OFF AND DISCONNECT THE POWER PLUG FROM THE WALL OUTLET BEFORE REPLACING THE LAMP UNIT.

**CAUTION:** To assure continued compliance, follow the attached installation instructions. This includes using the provided power cord and shielded interface cables when connecting to computer or peripheral devices. Also, any unauthorized changes or modifications to this equipment could void the user’s authority to operate this device.

This is a device to project images onto a screen, etc., and is not intended for use as indoor lighting in a domestic environment.

Directive 2009/125/EC

**Importer's name and address within the European Union**

**Panasonic Marketing Europe GmbH**  
**Panasonic Testing Centre**  
**Winsbergring 15, 22525 Hamburg, Germany**

## Read this first!

### WARNING:

- Not for use in a computer room as defined in the Standard for the Protection of Electronic Computer/Data Processing Equipment, ANSI/NFPA 75.
- For permanently connected equipment, a readily accessible disconnect device shall be incorporated in the building installation wiring.
- For pluggable equipment, the socket-outlet shall be installed near the equipment and shall be easily accessible.

### CAUTION (North/Middle/South America)

**CAUTION:** This equipment is equipped with a three-pin grounding-type power plug. Do not remove the grounding pin on the power plug. This plug will only fit a grounding-type power outlet. This is a safety feature. If you are unable to insert the plug into the outlet, contact an electrician. Do not defeat the purpose of the grounding plug.

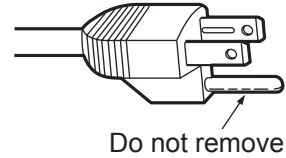

### FCC NOTICE (USA)

#### Declaration of Conformity

Model Number: PT-VW350, PT-VX420  
Trade Name : Panasonic  
Responsible Party : Panasonic Corporation of North America  
Address : Two Riverfront Plaza, Newark, NJ 07102-5490  
General Contact : <http://www.panasonic.com/support>  
Projector Contact : <http://panasonic.net/avc/projector/>

This device complies with Part 15 of the FCC Rules.

Operation is subject to the following two conditions:

(1) This device may not cause harmful interference, and (2) this device must accept any interference received, including interference that may cause undesired operation.

To assure continued compliance, follow the attached installation instructions and do not make any unauthorized modifications.

#### CAUTION:

This equipment has been tested and found to comply with the limits for a Class B digital device, pursuant to Part 15 of the FCC Rules. These limits are designed to provide reasonable protection against harmful interference in a residential installation. This equipment generates, uses and can radiate radio frequency energy and, if not installed and used in accordance with the instructions, may cause harmful interference to radio communications. However, there is no guarantee that interference will not occur in a particular installation. If this equipment does cause harmful interference to radio or television reception, which can be determined by turning the equipment off and on, the user is encouraged to try to correct the interference by one of the following measures:

- Reorient or relocate the receiving antenna.
- Increase the separation between the equipment and receiver.
- Connect the equipment into an outlet on a circuit different from that to which the receiver is connected.
- Consult the dealer or an experienced radio/TV technician for help.

The user may find the booklet "Something About Interference" available from FCC local regional offices helpful.

#### FCC Warning:

To assure continued FCC emission limit compliance, follow the attached installation instructions. This includes using the provided power cord and shielded interface cables when connecting to computer or peripheral devices. Also, any unauthorized changes or modifications to this equipment could void the user's authority to operate this device.

### NOTIFICATION (Canada)

This class B digital apparatus complies with Canadian ICES-003.

#### Notice (USA only):

- This product has a High Intensity Discharge (HID) lamp that contains mercury. Disposal may be regulated in your community due to environmental considerations. For disposal or recycling information, please visit Panasonic website: <http://www.panasonic.com/environmental> or call 1-888-769-0149.

**IMPORTANT: THE MOULDED PLUG (U.K. only)**

FOR YOUR SAFETY, PLEASE READ THE FOLLOWING TEXT CAREFULLY.

This appliance is supplied with a moulded three pin mains plug for your safety and convenience. A 13 amp fuse is fitted in this plug. Should the fuse need to be replaced, please ensure that the replacement fuse has a rating of 13 amps and that it is approved by ASTA or BSI to BS1362.

Check for the ASTA mark  or the BSI mark  on the body of the fuse.

If the plug contains a removable fuse cover, you must ensure that it is refitted when the fuse is replaced. If you lose the fuse cover, the plug must not be used until a replacement cover is obtained. A replacement fuse cover can be purchased from an Authorised Service Center.

If the fitted moulded plug is unsuitable for the mains socket in your home, then the fuse should be removed and the plug cut off and disposed of safely. There is a danger of severe electrical shock if the cut off plug is inserted into any 13 amp socket.

If a new plug is to be fitted, please observe the wiring code as shown below.  
If in any doubt, please consult a qualified electrician.

**WARNING:**        THIS APPLIANCE MUST BE EARTHED.

**IMPORTANT:**        The wires in this mains lead are coloured in accordance with the following code:

Green - and - Yellow:	Earth
Blue:	Neutral
Brown:	Live

As the colours of the wire in the mains lead of this appliance may not correspond with the coloured markings identifying the terminals in your plug, proceed as follows.

The wire which is coloured GREEN - AND - YELLOW must be connected to the terminal in the plug which is marked with the letter E or by the Earth symbol  or coloured GREEN or GREEN - AND - YELLOW.

The wire which is coloured BLUE must be connected to the terminal in the plug which is marked with the letter N or coloured BLACK.

The wire which is coloured BROWN must be connected to the terminal in the plug which is marked with the letter L or coloured RED.

How to replace the fuse: Open the fuse compartment with a screwdriver and replace the fuse.

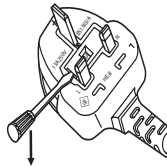

## To remove the battery

1. Press the guide and lift the cover.

2. Remove the batteries.

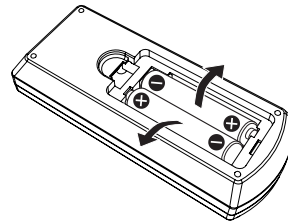
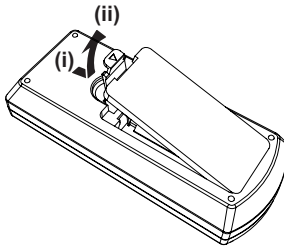

## Brazil Only Brasil Apenas

### Manuseio de baterias usadas

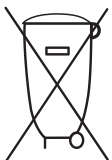

#### BRASIL

Após o uso, as pilhas e /ou baterias deverão ser entregues ao estabelecimento comercial ou rede de assistência técnica autorizada.

Cobrir os terminais positivo (+) e negativo (-) com uma fita isolante adesiva, antes de depositar numa caixa destinada para o recolhimento. O contato entre partes metálicas pode causar vazamentos, gerar calor, romper a blindagem e produzir fogo.(Fig. 1)

Fig. 1  
Como isolar os terminais

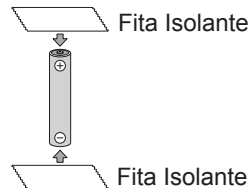

Não desmonte, não remova o invólucro, nem amasse a bateria. O gás liberado pela bateria pode irritar a garganta, danificar o lacre do invólucro ou o vazamento provocar calor, ruptura da blindagem e produzir fogo devido ao curto circuito dos terminais. Não incinere nem aqueça as baterias, elas não podem ficar expostas a temperaturas superiores a 100 °C (212 °F). O gás liberado pela bateria pode irritar a garganta, danificar o lacre do invólucro ou o vazamento provocar calor, ruptura da blindagem e produzir fogo devido ao curto circuito dos terminais provocado internamente.

Evite o contato com o líquido que vazar das baterias. Caso isto ocorra, lave bem a parte afetada com bastante água. Caso haja irritação, consulte um médico.

### Remoção das baterias

1. Pressione a guia e levante a tampa.

2. Remova as baterias.

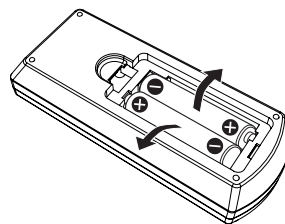
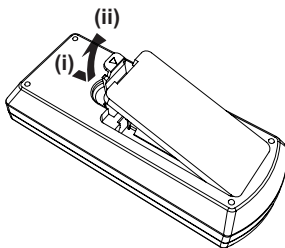

**WARNING:**

■ **POWER**

**The wall outlet shall be installed near the equipment and shall be easily accessible when problems occur. If the following problems occur, disconnect the power plug from the wall outlet immediately.**

Continued use of the projector in these conditions will result in fire or electric shock.

- If foreign objects or water get inside the projector, disconnect the power plug from the wall outlet.
- If the projector is dropped or the cabinet is broken, disconnect the power plug from the wall outlet.
- If you notice smoke, strange smells or noise coming from the projector, disconnect the power plug from the wall outlet.
- You have to disconnect the power plug from the wall outlet to cut off the power supply.

Please contact an Authorized Service Center for repairs, and do not attempt to repair the projector yourself.

**During a thunderstorm, do not touch the projector or the cable.**

Electric shocks can result.

**Do not do anything that might damage the power cord or the power plug.**

If the power cord is used while damaged, electric shocks, short-circuits or fire will result.

- Do not damage the power cord, make any modifications to it, place it near any hot objects, bend it excessively, twist it, pull it, place heavy objects on top of it or wrap it into a bundle.

Ask an Authorized Service Center to carry out any repairs to the power cord that might be necessary.

**Completely insert the power plug into the wall outlet and the power connector into the projector terminal.**

If the plug is not inserted correctly, electric shocks or overheating will result.

- Do not use plugs which are damaged or wall outlets which are coming loose from the wall.

**Do not use anything other than the provided power cord.**

Failure to observe this will result in fire or electric shocks. Please note that if you do not use the provided power cord to ground the device on the side of the outlet, this may result in electric shocks.

**Clean the power plug regularly to prevent it from becoming covered in dust.**

Failure to observe this will cause a fire.

- If dust builds up on the power plug, the resulting humidity can damage the insulation.
- If not using the projector for an extended period of time, pull the power plug out from the wall outlet. Pull the power plug out from the wall outlet and wipe it with a dry cloth regularly.

**Do not handle the power plug and power connector with wet hands.**

Failure to observe this will result in electric shocks.

**Do not overload the wall outlet.**

If the power supply is overloaded (ex., by using too many adapters), overheating may occur and fire will result.

■ **ON USE/INSTALLATION**

**Do not place the projector on soft materials such as carpets or sponge mats.**

Doing so will cause the projector to overheat, which can cause burns, fire or damage to the projector.

**Do not set up the projector in humid or dusty places or in places where the projector may come into contact with oily smoke or steam, ex. a bathroom.**

Using the projector under such conditions will result in fire, electric shocks or components deterioration. Components deterioration (such as ceiling mount brackets) may cause the projector which is mounted on the ceiling to fall down.

**Do not install this projector in a place which is not strong enough to take the full weight of the projector or on top of a surface which is sloped or unstable.**

Failure to observe this will cause projector to fall down or tip over the projector, and severe injury or damage could result.

**Installation work (such as ceiling mount bracket) should only be carried out by a qualified technician.**

If installation is not carried out and secured correctly, it can cause injury or accidents, such as electric shocks.

- Be sure to use the wire provided with the ceiling mount bracket as an extra safety measure to prevent the projector from falling down. (Install in a different location to the ceiling mount bracket.)

**Do not cover the air intake/exhaust ports.**

Doing so will cause the projector to overheat, which can cause fire or damage to the projector.

- Do not place the projector in narrow, badly ventilated places.
- Do not place the projector on cloth or papers, as these materials could be drawn into the air intake port.
- Provide at least 1 m (40") of space between any walls or objects and the exhaust port, and at least 50 cm (20") of space between any walls or objects and the intake port.

**Do not place your hands or other objects close to the air exhaust port.**

Doing so will cause burns or damage your hands or other objects.

- Heated air comes out of the air exhaust port. Do not place your hands or face, or objects which cannot withstand heat close to this port.

## **WARNING:**

**Do not look at or place your skin into the lights emitted from the lens while the projector is being used.**

Doing so can cause burns or loss of sight.

- Strong light is emitted from the projector's lens. Do not look at or place your hands directly into this light.
- Be especially careful not to let young children look into the lens. In addition, turn off the power and disconnect the power plug when you are away from the projector.

**Never attempt to remodel or disassemble the projector.**

High voltages can cause fire or electric shocks.

- For any inspection, adjustment and repair work, please contact an Authorized Service Center.

**Do not allow metal objects, flammable objects, or liquids to enter inside of the projector. Do not allow the projector to get wet.**

Doing so may cause short circuits or overheating, and result in fire, electric shock, or malfunction of the projector.

- Do not place containers of liquid or metal objects near the projector.
- If liquid enters inside of the projector, consult your dealer.
- Particular attention must be paid to children.

**Use the ceiling mount bracket specified by Panasonic.**

Using the ceiling mount bracket other than the specified one will result in falling accidents.

- Attach the supplied safety cable to the ceiling mount bracket to prevent the projector from falling down.

## **■ ACCESSORIES**

**Do not use or handle the batteries improperly, and refer to the following.**

Failure to observe this will cause burns, batteries to leak, overheat, explode or catch fire.

- Do not use unspecified batteries.
- Do not use chargeable batteries.
- Do not disassemble dry cell batteries.
- Do not heat the batteries or place them into water or fire.
- Do not allow the + and - terminals of the batteries to come into contact with metallic objects such as necklaces or hairpins.
- Do not store or carry batteries together with metallic objects.
- Store the batteries in a plastic bag and keep them away from metallic objects.
- Make sure the polarities (+ and -) are correct when inserting the batteries.
- Do not use a new battery together with an old battery or mix different types of batteries.
- Do not use batteries with the outer cover peeling away or removed.

**Do not allow children to reach the batteries.**

Accidentally swallowing them can cause physical harm.

- If swallowed, seek medical advice immediately.

**If the battery fluid leaks, do not touch it with bare hands, and take the following measures if necessary.**

- Battery fluid on your skin or clothing could result in skin inflammation or injury.  
Rinse with clean water and seek medical advice immediately.
- Battery fluid coming in contact with your eyes could result in loss of sight.  
In this case, do not rub your eyes. Rinse with clean water and seek medical advice immediately.

**Do not disassemble the lamp unit.**

If the lamp breaks, it could cause injury.

### **Lamp replacement**

The lamp has high internal pressure. If improperly handled, an explosion and severe injury or accidents will result.

- The lamp can easily explode if struck against hard objects or dropped.
- Before replacing the lamp unit, be sure to turn the power off and to disconnect the power plug from the wall outlet.  
Electric shocks or explosions can result if this is not done.
- When replacing the lamp unit, turn the power off and allow the lamp to cool for at least 1 hour before handling it otherwise it can cause burns.

**Do not use the supplied power cord with devices other than this projector.**

- Using the supplied power cord with devices other than this projector may cause short circuits or overheating, and result in electric shock or fire.

**Remove the depleted batteries from the remote control promptly.**

- Leaving them in the unit may result in fluid leakage, overheating, or explosion of the batteries.

## **CAUTION:**

### **■ POWER**

**When disconnecting the power cord, be sure to hold the power plug and power connector.**

If the power cord itself is pulled, the lead will become damaged, and fire, short-circuits or serious electric shocks will result.

**When not using the projector for an extended period of time, disconnect the power plug from the wall outlet.**

Failure to do so may result in fire or electric shock.

**Disconnect the power plug from the wall outlet before carrying out any cleaning and replacing the unit.**

Failure to do so may result in electric shock.

### **■ ON USE/INSTALLATION**

**Do not place heavy objects on top of the projector.**

Failure to observe this will cause the projector to become unbalanced and fall, which could result in damage or injury. The projector will be damaged or deformed.

**Do not put your weight on this projector.**

You could fall or the projector could break, and injury will result.

- Be especially careful not to let young children stand or sit on the projector.

**Do not place the projector in extremely hot locations.**

Doing so will cause the outer casing or internal components to deteriorate, or result in fire.

- Take particular care in locations exposed to direct sunlight or near stoves.

**Do not place the projector where it may be affected by salt or corrosive gas.**

Doing so may cause the projector to become faulty due to corrosion.

**Do not place objects in front of the lens while the projector is being used.**

Doing so can cause fire or damage to the object and can cause the projector to malfunction.

- Extremely strong light is emitted from the projector's lens.

**Do not stand in front of the lens while the projector is being used.**

Doing so can cause damage and burns to clothing.

- Extremely strong light is emitted from the projector's lens.

**Always disconnect all cables before moving the projector.**

Moving the projector with cables still attached can damage the cables, which will cause fire or electric shocks to occur.

**When mounting the projector on the ceiling, keep mounting screws and power cord from contact with metal parts inside the ceiling.**

Contact with metal parts inside the ceiling can cause electric shocks.

**Never plug headphones and earphones into <VARIABLE AUDIO OUT> terminal.**

Excessive sound pressure from earphones and headphones can cause hearing loss.

### **■ ACCESSORIES**

**Do not use the old lamp unit.**

If used it could cause lamp explosion.

**If the lamp has broken, ventilate the room immediately. Do not touch or bring your face close to the broken pieces.**

Failure to observe this will cause the user to absorb the gas which was released when the lamp broke and which contains nearly the same amount of mercury as fluorescent lamp, and the broken pieces will cause injury.

- If you believe that you have absorbed the gas or that the gas has got into your eyes or mouth, seek medical advice immediately.
- Ask your dealer about replacing the lamp unit and check the inside of the projector.

**When not using the projector for an extended period of time, remove the batteries from the remote control.**

Failure to observe this will cause the batteries to leak, overheat, catch fire or explode, which may result in fire or contamination of surrounding area.

### **■ MAINTENANCE**

**Ask your dealer about cleaning inside the projector once a year.**

Continuous use while dust is accumulated inside the projector may result in fire.

- For cleaning fee, ask your dealer.



---

### ■ Trademarks, etc.

- Windows, Windows Vista and Internet Explorer are registered trademarks or trademarks of Microsoft Corporation in the United States and other countries.
- Mac, Mac OS, OS X, and Safari are trademarks of Apple Inc., registered in the United States and other countries.
- HDMI, the HDMI logo and High-Definition Multimedia Interface is a trademark or registered trademark of HDMI Licensing LLC.
- PJLink™ is a trademark or pending trademark in Japan, the United States, and other countries and regions.
- RoomView and Crestron RoomView are registered trademarks of Crestron Electronics, Inc. Crestron Connected™ and Fusion RV are trademarks of Crestron Electronics, Inc.
- Adobe, Adobe Flash Player and Adobe Reader are trademarks or registered trademarks of Adobe Systems Inc. in the United States and/or other countries.
- Some of the fonts used in the on-screen menu are Ricoh bitmap fonts, which are manufactured and sold by Ricoh Company, Ltd.
- Other names, company names or product names used in these operating instructions are the trademarks or registered trademarks of their respective holders.  
Please note that the operating instructions do not include the ® and ™ symbols.

### Software information regarding this product

This product incorporates the following software.

- (1) The software which is developed independently by or for Panasonic Corporation
- (2) The software owned by third party and licensed to Panasonic Corporation
- (3) The software which is licensed under the GNU LESSER GENERAL PUBLIC LICENSE Version2.1 (LGPL V2.1)

The software categorized as (3), the license is available in accordance with gnu lesser general public license, it is distributed in the hope that it will be useful, but without any warranty, without even the implied warranty of merchantability or fitness for a particular purpose. As for the terms and conditions, please refer to the software license of the supplied CD-ROM.

If you wish to ask any questions as to the software, please contact (sav.pj.gpl.pavc@ml.jp.panasonic.com) by email.

### ■ Illustrations in these operating instructions

- Note that illustrations of the projector and screens may differ from the ones you actually see.

### ■ Page references

- In these instructions, references to pages are indicated as: (➡ page 00).

### ■ Term

- In these instructions, the “Wireless remote control unit” accessory is referred to as the “Remote control”.

---

## Features of the Projector

---

### High Contrast

---

- ▶ A high contrast of 12 000:1 is achieved by the unique optical system.

### Auto Setup Function

---

- ▶ This function executes [SHIFT], [CLOCK PHASE], [DOT CLOCK] at the same time by pressing the <AUTO SETUP> button.

### Direct Power Off Function

---

- ▶ With the Direct Power Off function, you can disconnect the power cord from the wall outlet or turn off the breaker even during projection.

### Wired LAN Function

---

- ▶ This function allows you to project an image on a computer as well as operate and manage the projector via network.

### Useful Functions for Presentations

---

- ▶ The digital zoom function allows you to focus on the crucial information during a presentation.
- ▶ The MIC function and 10 W audio output allows you to make a presentation without any external audio equipment.

## Quick Steps

---

For details, see the corresponding pages.

1. **Set up your projector.**  
(⇒ page 26)



2. **Connect with other devices.**  
(⇒ page 30)



3. **Connect the power cord.**  
(⇒ page 35)



4. **Power on.**  
(⇒ page 36)



5. **Make initial settings.**  
(⇒ page 36)

- Take this step when you power on for the first time after purchasing the projector.



6. **Select the input signal.**  
(⇒ page 40)



7. **Adjust the image.**  
(⇒ page 40)

# Contents

Be sure to read “Read this first!” from page 2.

## Read this first! ..... 2

## Chapter 1 Preparation

<b>Precautions for use</b> .....	<b>14</b>
Cautions when transporting.....	14
Cautions when installing.....	14
Security .....	15
Disposal.....	16
Cautions on use .....	16
Accessories .....	17
Contents of the supplied CD-ROM.....	18
Optional accessories .....	18
<b>About your projector</b> .....	<b>19</b>
Remote control .....	19
Projector body .....	20
<b>Preparing the remote control</b> .....	<b>23</b>
Inserting and removing batteries .....	23
When using the system with multiple projectors ..	23
<b>Attaching the Lens Cap</b> .....	<b>24</b>

## Chapter 2 Getting Started

<b>Setting up</b> .....	<b>26</b>
Installation mode .....	26
Parts for ceiling mount (optional).....	26
Screen size and throw distance .....	27
Adjusting adjustable feet .....	29
<b>Connecting</b> .....	<b>30</b>
Before connecting .....	30
Connecting example : AV equipment .....	32
Connecting example : Computers .....	32
Connecting example : Audio.....	33

## Chapter 3 Basic Operations

<b>Powering on/off</b> .....	<b>35</b>
Connecting the power cord .....	35
Power indicator.....	35
Powering On the Projector .....	36
When the initial setting screen is displayed.....	36
Making adjustments and selections .....	38
Powering Off the Projector .....	39
Direct Power Off function .....	39
<b>Projecting</b> .....	<b>40</b>
Selecting the input signal .....	40
How to adjust the state of the image .....	40
<b>Basic operations by using the remote control</b> .....	<b>41</b>
Using the AUTO SETUP function.....	41
Using the KEYSTONE button.....	41
Switching the input signal.....	42
Using the FUNCTION button.....	42
Using the FREEZE function .....	42

Using the AV MUTE function .....	43
Using the P-TIMER function.....	43
Using the DIGITAL ZOOM function .....	43
Controlling the volume of the speaker.....	44
Using the MUTE function .....	44
Using the P IN P function .....	45
Setting the ID number of the remote control .....	45

## Chapter 4 Settings

<b>Menu Navigation</b> .....	<b>47</b>
Navigating through the menu .....	47
Resetting adjustment values to the factory default.....	48
Main menu.....	48
Sub-menu .....	49
<b>[PICTURE] menu</b> .....	<b>51</b>
[PICTURE MODE].....	51
[CONTRAST].....	51
[BRIGHTNESS].....	52
[COLOR].....	52
[TINT] .....	52
[SHARPNESS] .....	52
[COLOR TEMPERATURE].....	53
[IRIS] .....	53
[ADVANCED MENU] .....	53
[DAYLIGHT VIEW].....	53
[DIGITAL CINEMA REALITY] .....	54
[NOISE REDUCTION].....	54
[TV-SYSTEM] .....	54
[RGB/YPbPr]/[RGB/YCbCr].....	55
<b>[POSITION] menu</b> .....	<b>56</b>
[REALTIME KEYSTONE] .....	56
[KEYSTONE].....	56
[SHIFT].....	58
[DOT CLOCK].....	58
[CLOCK PHASE].....	58
[OVER SCAN] .....	59
[ASPECT] .....	59
[FRAME LOCK] .....	60
<b>[LANGUAGE] menu</b> .....	<b>61</b>
[LANGUAGE] .....	61
<b>[DISPLAY OPTION] menu</b> .....	<b>62</b>
[ON-SCREEN DISPLAY].....	62
[HDMI SIGNAL LEVEL].....	63
[CLOSED CAPTION SETTING].....	63
[SCREEN SETTING] .....	64
[STARTUP LOGO].....	64
[AUTO SETUP SETTING].....	65
[SIGNAL SEARCH] .....	65
[BACK COLOR].....	65
[WIDE MODE] .....	65
[SXGA MODE].....	65

[P-TIMER].....	66	<b>Specifications</b> .....	114
[P IN P].....	67	<b>Dimensions</b> .....	116
[OTHER FUNCTIONS].....	67	<b>Ceiling mount bracket safeguards</b> .....	117
<b>[PROJECTOR SETUP] menu</b> .....	<b>69</b>	<b>Index</b> .....	<b>118</b>
[STATUS].....	69		
[COMPUTER2 SELECT].....	69		
[PROJECTOR ID].....	69		
[INITIAL START UP].....	70		
[PROJECTION METHOD].....	70		
[HIGH ALTITUDE MODE].....	70		
[LAMP POWER] .....	71		
[ECO MANAGEMENT].....	71		
[EMULATE].....	72		
[FUNCTION BUTTON] .....	73		
[AUDIO SETTING] .....	73		
[TEST PATTERN] .....	75		
[FILTER COUNTER].....	75		
[INITIALIZE ALL] .....	75		
<b>[SECURITY] menu</b> .....	<b>76</b>		
[PASSWORD].....	76		
[PASSWORD CHANGE] .....	76		
[TEXT DISPLAY] .....	77		
[TEXT CHANGE].....	77		
[MENU LOCK].....	77		
[MENU LOCK PASSWORD] .....	77		
[CONTROL DEVICE SETUP].....	78		
<b>[NETWORK] menu</b> .....	<b>79</b>		
[WIRED LAN] .....	79		
[NAME CHANGE].....	80		
[NETWORK CONTROL] .....	80		
[AMX D.D.] .....	80		
[Crestron Connected(TM)].....	80		
[STATUS].....	81		
[INITIALIZE].....	81		
Network connections .....	81		
Accessing from the web browser .....	83		

## Chapter 5 Maintenance

<b>Lamp and Warning Indicators</b> .....	<b>98</b>
When an indicator lights up .....	98
<b>Maintenance/replacement</b> .....	<b>99</b>
Before performing maintenance/replacement .....	99
Maintenance .....	99
Replacing the unit.....	99
<b>Troubleshooting</b> .....	<b>103</b>

## Chapter 6 Appendix

<b>Technical Information</b> .....	<b>105</b>
PJLink protocol.....	105
Control commands via LAN.....	106
Serial terminal .....	108
[MENU LOCK PASSWORD] operations .....	110
Two window display combination list.....	111
List of compatible signals .....	112

# Chapter 1 Preparation

---

This chapter describes things you need to know or check before using the projector.

# Precautions for use

## Cautions when transporting

- When transporting the projector, hold it securely by its bottom and avoid excessive vibration and impacts. Doing so may damage the internal parts and result in malfunctions.
- Do not transport the projector with the adjustable feet extended. Doing so may damage the adjustable feet.

## Cautions when installing

### ■ Do not set up the projector outdoors.

- The projector is designed for indoor use only.

### ■ Do not use under the following conditions.

- Places where vibration and impacts occur such as in a car or vehicle: Doing so may damage the internal parts and result in malfunctions.
- Locations near the sea or areas affected by corrosive gas: Corrosion may damage internal components or cause the projector to malfunction.
- Near the exhaust of an air conditioner: Depending on the conditions of use, the screen may fluctuate in rare cases due to the heated air from the air exhaust port or the hot or cooled air. Make sure that the exhaust from the projector or other equipment, or the air from the air conditioner does not blow toward the front of the projector.
- Places with sharp temperature fluctuations such as near lights (studio lamp): Doing so may shorten the life of the lamp, or result in deformation of the outer case due to heat, which may cause malfunctions.

The operating environment temperature of the projector should be between 0 °C (32 °F) and 40 °C (104 °F)\*1 when using it at elevations lower than 1 400 m (4 593') above sea level, and between 0 °C (32 °F) and 30 °C (86 °F) when using it at high altitudes (between 1 400 m (4 593') and 2 700 m (8 858') above sea level).

\*1 When the operating environment temperature of the projector is between 35 °C (95°F) and 40 °C (104 °F), the lamp mode will change to [ECO] automatically.

- Near high-voltage power lines or near motors: Doing so may interfere with the operation of the projector.

### ■ Be sure to ask a specialized technician when installing the product to a ceiling.

This requires an optional ceiling mount bracket. Be sure to use the Projector Mount Bracket together with the ceiling mount bracket for high ceilings or low ceilings.

Model No.:

- ① ET-PKL100H (for high ceilings), ET-PKV400B (Projector Mount Bracket)
- ② ET-PKL100S (for low ceilings), ET-PKV400B (Projector Mount Bracket)

### ■ Focus adjustment

The projection lens is thermally affected by the light from the light source, making the focus unstable in the period just after switching on the power. It is recommended that the images are projected continuously for at least 30 minutes before the focus is adjusted.

### ■ When using the projector in the elevation of below 1 400 m (4 593'), make sure [HIGH ALTITUDE MODE] is set to [OFF].

Failure to do so may shorten the life of the internal parts and result in malfunctions.

### ■ When using the projector in the elevation of above 1 400 m (4 593') and below 2 000 m (6 562'), make sure [HIGH ALTITUDE MODE] is set to [HIGH1].

Failure to do so may shorten the life of the internal parts and result in malfunctions.

### ■ When using the projector in the elevation of above 2 000 m (6 562') and below 2 700 m (8 858'), make sure [HIGH ALTITUDE MODE] is set to [HIGH2].

Failure to do so may shorten the life of the internal parts and result in malfunctions.

### ■ Do not install the projector at elevations of 2 700 m (8 858') or higher above sea level.

Failure to do so may shorten the life of the internal parts and result in malfunctions.

### ■ Do not tilt the projector or place it on its side.

Do not tilt the projector body more than approximately  $\pm 40$  degrees vertically or  $\pm 15$  degrees horizontally. Over tilting may result in shortening the life of the components.

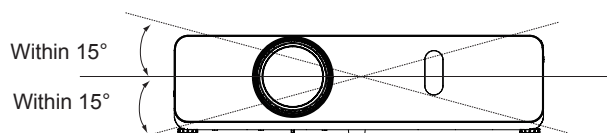
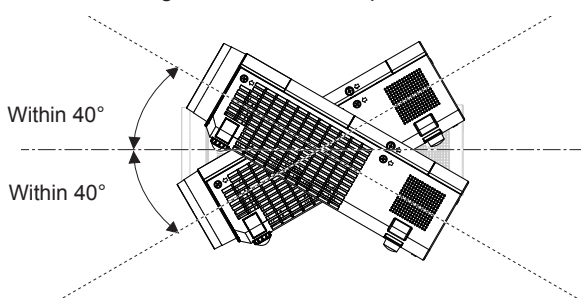

■ **Cautions when setting the projectors**

- If you want to use the projector other than the way of setting on the desk/floor with the adjustable feet or mounting on the ceiling, use the three screw holes for ceiling mounting (as shown below) to fix the projector.  
(Screw: M4; Depth of the screw hole: 8 mm (5/16"); Torque: M4 1.25 ± 0.2 N·m)  
In addition, always keep a gap of more than 20 mm (25/32") between the bottom of the projector and installation surface. Make sure that there is no clearance of at least 20 mm (25/32") between the screw holes for ceiling mounting and the installation surface by inserting supports (metallic) between them.

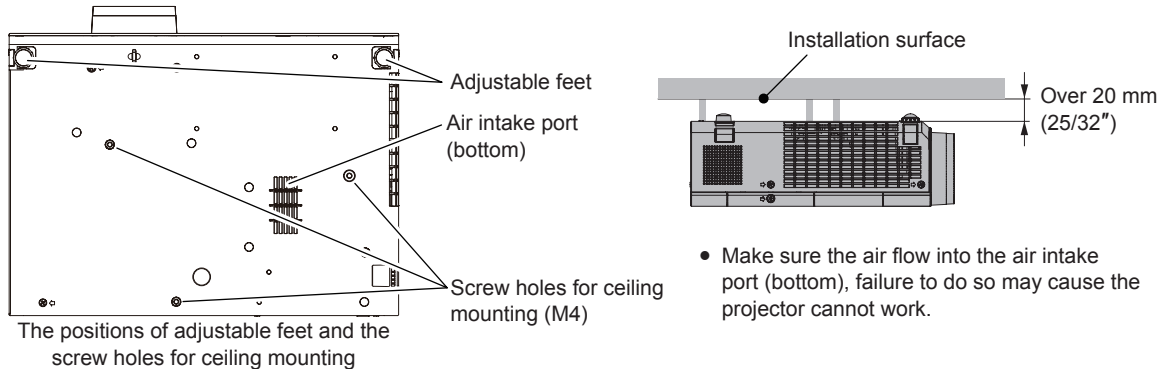

- Do not stack the projectors.
- Do not use the projector supporting it by the top.
- Do not block the ventilation ports (intake and exhaust) of the projector.
- Avoid heating and cooling air from the air conditioning system directly blow to the ventilation ports (intake and exhaust) of the projector.

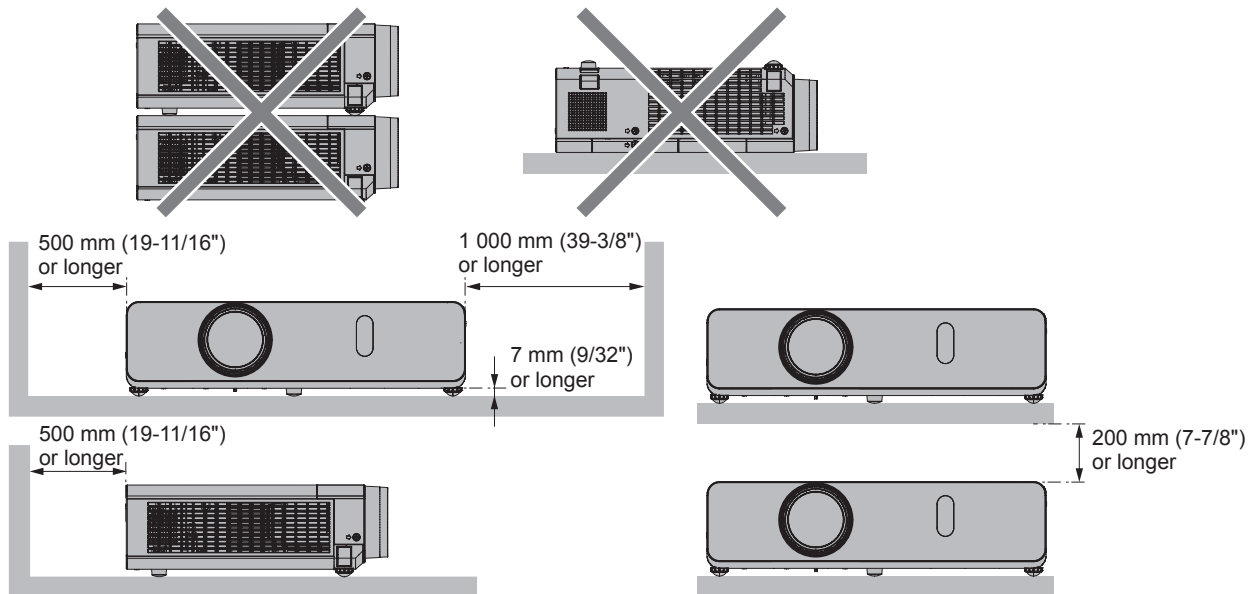

- Do not install the projector in a confined space.  
When placing the projector in a confined space, a ventilation and/or air conditioning system is required. Exhaust heat may accumulate when the ventilation is not enough, triggering the protection circuit of the projector.

**Security**

Take safety measures against following incidents.

- Personal information being leaked via this product.
  - Unauthorized operation of this product by a malicious third party.
  - Interfering or stopping of this product by a malicious third party.
- Security instruction (▶ pages 76, 93)
- Make your password as difficult to guess as possible.
  - Change your password periodically.
  - Panasonic or its affiliate company never inquires a password directly to a customer. Do not tell your password in case you receive such an inquiry.
  - The connecting network must be secured by firewall or others.
  - Set a password for web control and restrict the users who can log in.

## Disposal

---

To dispose of the product, ask your local authorities or dealer for correct methods of disposal.

The lamp contains mercury. When disposing of used lamp units, contact your local authorities or dealer for correct methods of disposal.

## Cautions on use

---

### ■ To get a good picture quality

- In order to view a beautiful image in higher contrast, prepare an appropriate environment. Draw curtains or blinds over windows and turn off any lights near the screen to prevent outside light or light from indoor lamp from shining onto the screen.

### ■ Do not touch the surface of the projector lens with your bare hands.

If the surface of the projection lens becomes dirty from fingerprints or anything else, this will be magnified and projected onto the screen.

Attach the supplied lens cap to the projection lens when you do not use the projector.

### ■ LCD panel

The LCD panel is precision-made. Note that in rare cases, pixels of high precision could be missing or always lit. Note that such phenomena do not indicate malfunction. If still images are projected for a long time, a residual image may remain on the LCD panel. Note that the residual image may not disappear.

### ■ Optical parts

When the operating environment temperature is high or in environments where lots of dust, cigarette smoke, etc. is present, the replacement cycle of the LCD panel, polarizing plate and other optical parts may be shorter even if used for less than one year. Consult your dealer for details.

### ■ Lamp

The luminous source of the projector is a mercury lamp with high internal pressure.

A high-pressure mercury lamp has the following characteristics.

- The luminance of the lamp will decrease by duration of usage.
- The lamp may burst with a loud sound or have its service life shortened because of shock, chipping, or degradation due to cumulative runtime.
- The life of the lamp varies greatly depending on individual specificities and usage conditions. In particular, continuous use over 12 hours and frequent switching off/on of the power greatly deteriorate the lamp and affect the lamp life.
- In rare cases, the lamp burst shortly after the projection.
- The risk of bursting increases when the lamp is used beyond its replacement cycle. Make sure to replace the lamp unit consistently. ("When to replace the lamp unit" (➡ page 101), "Replacing the Lamp unit" (➡ page 101))
- If the lamp bursts, gas contained inside of the lamp is released in a form of smoke.
- It is recommended to store replacement lamp for contingency.

### ■ Computer and external device connections

- When connecting a computer or an external device, read this manual carefully regarding the use of power cords and shielded cables as well.



## Accessories

Make sure the following accessories are provided with your projector. Numbers enclosed < > show the number of accessories.

**Wireless remote control unit <1>**  
(N2QAYA000071) (N2QAYA000070)

PT-VW350



PT-VX420



**CD-ROM <1>**  
(TXFQB02WYKZ)

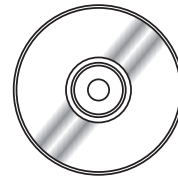

**Power cord**  
(TXFSX02UXRZ)

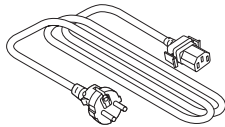

(TXFSX02UYAZ)

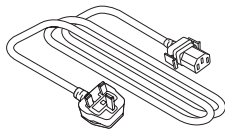

(TXFSX02UFEZ)

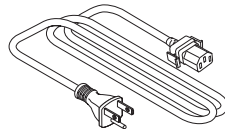

**AAA/R03 or AAA/LR03 battery <2>**

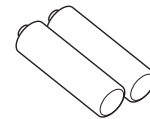

(for remote control unit)

**String <1>**  
(for lens cap)  
(6103504711)

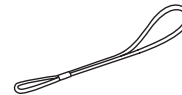

**Lens cap <1>**  
(TKKL5568)

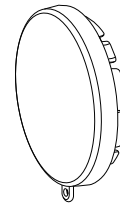

**RGB signal cable <1>**  
(K1HY15YY0012)

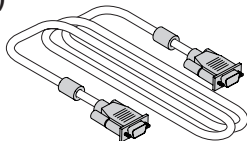

### Attention

- After unpacking the projector, discard the power cord cap and packaging material properly.
- Do not use the supplied power cord for devices other than this projector.
- For lost accessories, consult your dealer.
- Store small parts in an appropriate manner, and keep them away from young children.

### Note

- The type and number of the power cord depend on the country in which you purchased the product.
- The model numbers of accessories are subject to change without prior notice.
- The supplied string is used for lens cap, refer to “Attaching the Lens Cap” (➔ page 24).

## Contents of the supplied CD-ROM

The contents of the supplied CD-ROM are as follow.

Instruction / list (PDF)	Operating Instructions – Functional Manual	
	Operating Instructions – Multi Projector Monitoring & Control Software	
	Operating Instructions – Logo Transfer Software	
	List of compatible projector models	This is a list of projectors that are compatible with the software contained in the CD-ROM and their restrictions.
	Software license	The open source software licenses that used in this projector are included in the PDF files.
Software	Multi Projector Monitoring & Control Software (Windows)	This software allows you to monitor and control multiple projectors connected to the LAN.
	Logo Transfer Software (Windows)	This software allows you to transfer original images, such as company logos to be displayed when projection starts, to the projector.

## Optional accessories

Options	Model No.
Ceiling Mount Bracket	ET-PKL100H (for high ceilings) ET-PKL100S (for low ceilings) ET-PKV400B (Projector Mount Bracket)
Replacement Lamp Unit	ET-LAV300
Replacement Filter Unit	ET-RFV300

### Note

- The model numbers of optional accessories are subject to change without prior notice.

# About your projector

## Remote control

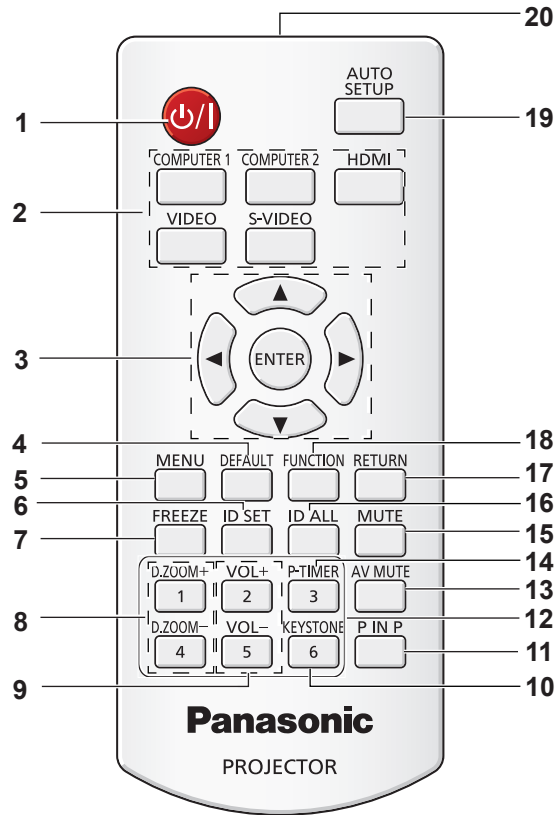

- |   |  |
|---|--|
| <p><b>1 Power &lt;P&gt;/&lt;I&gt; button</b><br/>Turn the projector on or off. (➔ pages 36, 39)<br/>(⏻ standby / ⏻ power on)</p> <p><b>2 Input Selection Buttons: &lt;COMPUTER 1&gt;, &lt;COMPUTER 2&gt;, &lt;HDMI&gt;, &lt;VIDEO&gt;, &lt;S-VIDEO&gt;</b><br/>These buttons are used to select the input signal.<br/>(➔ page 40)</p> <p><b>3 ▲▼◀▶ Buttons, &lt;ENTER&gt; Button</b><br/>Navigate the MENU display.</p> <p><b>4 &lt;DEFAULT&gt; Button</b><br/>Resets the content of the sub-menu to the factory default<br/>(➔ page 48). Or deletes one character when you enter<br/>an IP address or a text.</p> <p><b>5 &lt;MENU&gt; Button</b><br/>Open or close the On-Screen Menu. (➔ page 47)</p> <p><b>6 &lt;ID SET&gt; Button</b><br/>Sets the ID number of the remote control to use for a<br/>system using multiple projectors. (➔ page 23)</p> <p><b>7 &lt;FREEZE&gt; Button</b><br/>Pauses the projected image and mute the audio<br/>temporarily. (➔ page 42)</p> <p><b>8 &lt;D.ZOOM +/-&gt; Buttons</b><br/>Zoom in and out the images. (➔ page 43)</p> <p><b>9 &lt;VOL +/-&gt; Buttons</b><br/>Adjust the volume of the speaker. (➔ page 44)</p> <p><b>10 &lt;KEystone&gt; Button</b></p> | <p><b>11 &lt;P IN P&gt; Button</b> (Only for PT-VW350)<br/>Operate the P IN P function.</p> <p><b>12 Number buttons</b><br/>Act as number buttons. Use these buttons when setting<br/>the remote control codes or entering the password.</p> <p><b>13 &lt;AV MUTE&gt; Button</b><br/>Used to turn off the audio and video temporarily.<br/>(➔ page 43)</p> <p><b>14 &lt;P-TIMER&gt; Button</b><br/>Operate the P-timer function. (➔ page 43)</p> <p><b>15 &lt;MUTE&gt; Button</b><br/>Used to mute the audio. (➔ page 44)</p> <p><b>16 &lt;ID ALL&gt; Button</b><br/>Used to simultaneously control all the projectors with<br/>one remote control for a system using multiple projectors.<br/>(➔ page 23)</p> <p><b>17 &lt;RETURN&gt; Button</b><br/>Return to the previous menu or cancel the setting.</p> <p><b>18 &lt;FUNCTION&gt; Button</b><br/>Assigns a frequently used operation as a shortcut button.</p> <p><b>19 &lt;AUTO SETUP&gt; Button</b><br/>Automatically adjusts the image display position while<br/>projecting the image. (➔ page 41)</p> <p><b>20 Remote control signal emitter</b></p> |
|---|--|

**Attention**

- Do not drop the remote control.
- Avoid contact with liquids.
- Do not attempt to modify or disassemble the remote control.
- Please observe the following contents that are described on the back of the remote control unit (see the right picture).
  1. Do not use a new battery together with an old battery.
  2. Do not use unspecified batteries.
  3. Make sure the polarities (+ and -) are correct when inserting the batteries.
- In addition, please read the contents that are related to batteries in the "Read this first!".

CAUTION	
1. Do not use old battery with new one. 2. Do not use batteries other than the type specified. 3. Be sure the batteries are inserted properly.	

**Note**

- The remote control can be used within a distance of about 7 m (22'11-5/8") if pointed directly at the remote control signal receiver. The remote control can control at angles of up to  $\pm 30^\circ$  vertically and  $\pm 30^\circ$  horizontally, but the effective control range may be reduced.
- If there are any obstacles between the remote control and the remote control signal receiver, the remote control may not operate correctly.
- You can operate the projector by reflecting the remote control signal on the screen. The operating range may differ due to the loss of light caused by the properties of the screen.
- When the remote control signal receiver is lit with a fluorescent light or other strong light source, the projector may become inoperative. Set the projector as far from the luminous source as possible.

**Projector body**

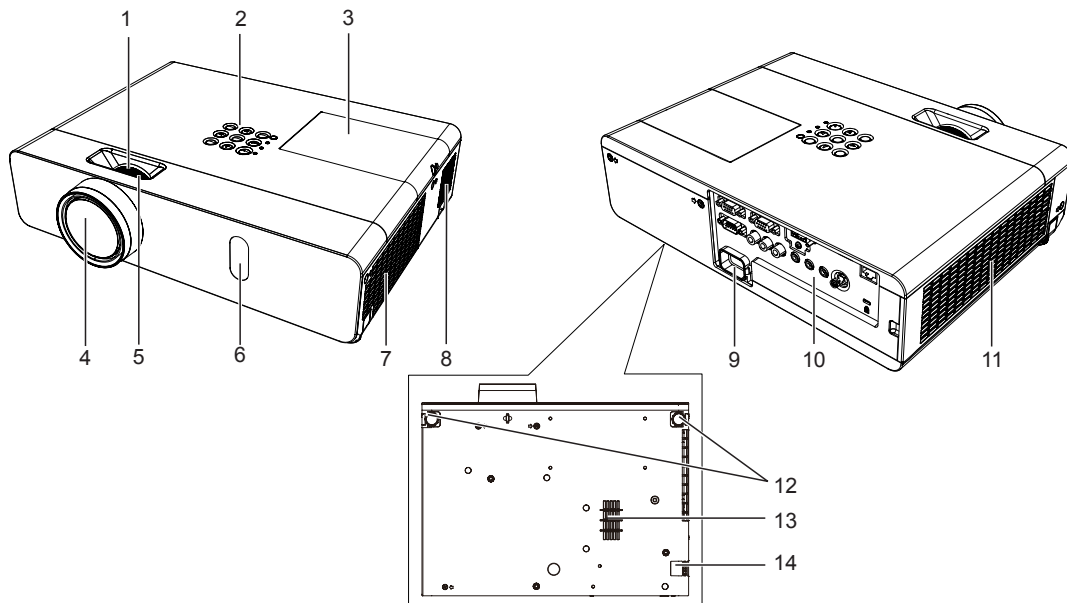

**WARNING**

**Keep your hands and other objects away from the air exhaust port and the air intake port (bottom).**

- Keep your hand and face away.
- Do not insert your finger.
- Keep heat-sensitive articles away.

Heated air from the air exhaust port can cause burns or external damage.

When using the projector on a ceiling and powering off with the Direct Power Off function, the heated air from the air intake port in the bottom can cause burns or external damage.

- |  |  |
|--|--|
| <p><b>1 Zoom ring (Back)</b><br/>Adjust the zoom.</p> <p><b>2 Control Panel and Indicators</b> (➔ page 21)</p> <p><b>3 Lamp cover</b> (➔ page 101)<br/>The lamp unit is located inside.</p> <p><b>4 Projection Lens</b></p> <p><b>5 Focus ring (Front)</b><br/>Adjust the focus.</p> <p><b>6 Remote control signal receiver</b></p> <p><b>7 Air exhaust port</b></p> <p><b>8 Speaker</b></p> | <p><b>9 &lt;AC IN&gt; terminal</b><br/>Connect the supplied power cord.</p> <p><b>10 Connecting terminals</b> (➔ page 22)</p> <p><b>11 Air intake port (Side) / Air filter cover</b> (➔ page 99)<br/>The air filter unit is inside.</p> <p><b>12 Adjustable feet</b><br/>Adjust the projection angle.</p> <p><b>13 Air intake port (Bottom)</b></p> <p><b>14 Security Chain Hook</b><br/>Attaches a burglar prevention cable, etc.</p> |
|--|--|

**Attention**

- Do not block the ventilation ports (intake and exhaust) of the projector.

**■ Control panel and Indicators**

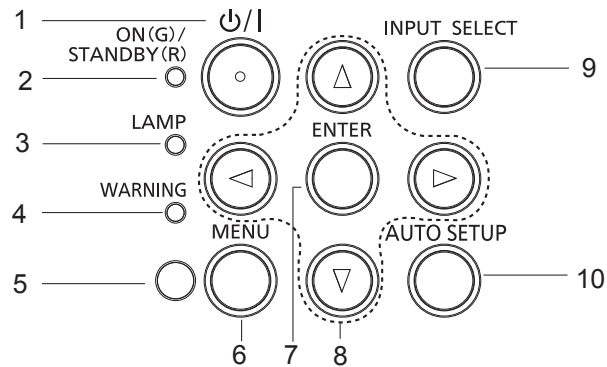

- |  |   |
|--|---|
| <p><b>1 Power &lt;⏻/⏻&gt; button</b><br/>Turns the projector on/off.<br/>(⏻ standby / ⏻ power on)</p> <p><b>2 Power indicator &lt;ON(G)/STANDBY(R)&gt;</b><br/>Displays the status of the power.</p> <p><b>3 Lamp indicator &lt;LAMP&gt;</b><br/>Displays the status of the lamp.</p> <p><b>4 Warning indicator &lt;WARNING&gt;</b><br/>Indicates the abnormal conditions of the projector.</p> <p><b>5 Ambient Luminance sensor</b><br/>Detects room's light and select proper image quality.</p> | <p><b>6 &lt;MENU&gt; button</b><br/>Displays the menu screen. (➡ page 47)</p> <p><b>7 &lt;ENTER&gt; button</b><br/>Determines and executes an item in the menu screen.</p> <p><b>8 ▲▼◀▶ buttons</b><br/>Navigates the MENU screen.<br/>Adjusts the volume level (◀▶).</p> <p><b>9 &lt;INPUT SELECT&gt; button</b><br/>Selects the input signal for projection.<br/>(➡ page 40)</p> <p><b>10 &lt;AUTO SETUP&gt; button</b><br/>Executes the auto setup function.</p> |
|--|---|

■ Connecting terminals

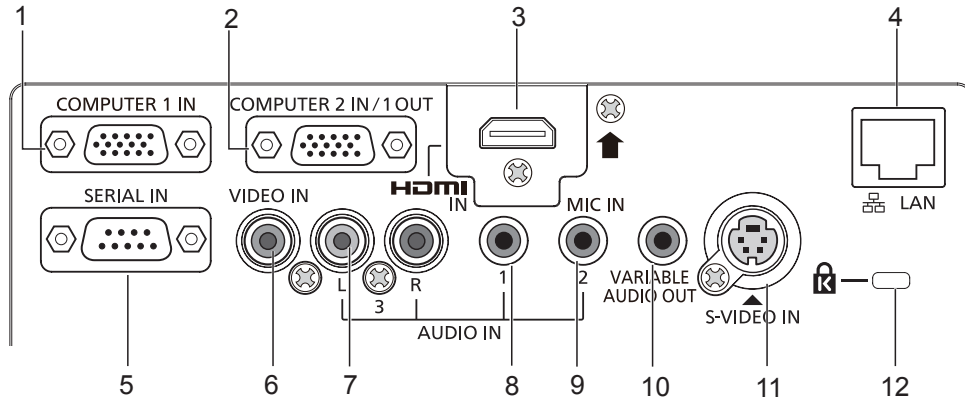

**1 <COMPUTER 1 IN> terminal**

This is the terminal to input RGB or  $YC_B C_R / YP_B P_R$  signals.

**2 <COMPUTER 2 IN/ 1 OUT> terminal**

This is the terminal to input RGB signals. Or output the RGB or  $YC_B C_R / YP_B P_R$  signals to external monitor.

**3 <HDMI IN> terminal**

This is the terminal to input HDMI signals.

**4 <LAN> terminal**

This is the LAN terminal to connect to the network.

**5 <SERIAL IN> terminal**

This is the RS-232C compatible terminal to externally control the projector by connecting a computer.

**6 <VIDEO IN> terminal**

This is the terminal to input video signals.

**7 <AUDIO IN 3 (L/R)> terminal**

This is the terminal to input audio signals. Left input (L) and right input (R) are provided for the <AUDIO IN 3> terminal.

**8 <AUDIO IN 1> terminal**

This is the terminal to input audio signals.

**9 <AUDIO IN 2 (MIC IN)> terminal**

This is the terminal to input audio signals. Or connect the MIC to this terminal.

**10 <VARIABLE AUDIO OUT> terminal**

This is the terminal to output the input audio signal to the projector.

**11 <S-VIDEO IN> terminal**

This is the terminal to input s-video signals.

**12 Security slot**

Attach the commercial shackle lock, manufactured by Kensington, to protect your projector. Compatible with the Kensington MicroSaver Security System.

**Attention**

- When a LAN cable is directly connected to the projector, the network connection must be made indoors.

# Preparing the remote control

## Inserting and removing batteries

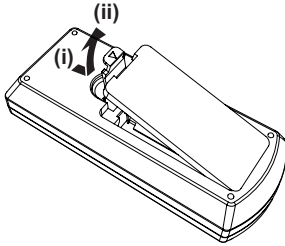

Fig. 1

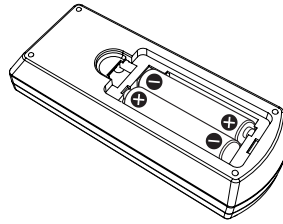



Fig. 2

- 1) Open the cover. (Fig. 1)
- 2) Insert batteries and close the cover. (Insert the  side first.) (Fig. 2)

- When removing the batteries, perform the steps in reverse order.

## When using the system with multiple projectors

When you use the system with multiple projectors, you can operate all the projectors simultaneously or each projector individually by using single remote control, if a unique ID number is assigned to each projector.

When you want to set the ID number, at first you need to complete the Initial setting, and then after setting the ID number of the projector, set the ID number on the remote control. About Initial setting, please refer to "When the initial setting screen is displayed" (➔ page 36).

The factory default ID number of the unit (the projector and the remote control) is set to [ALL], you can control with this setting. If necessary, please set the ID number to the remote control and the projector. About how to set the ID number of the remote control, please refer to "Setting the ID number of the remote control" (➔ page 45).

### Note

- Set the ID number of the projector from the [PROJECTOR SETUP] menu → [PROJECTOR ID]. (➔ page 69)

## Attaching the Lens Cap

When moving this projector or while not using it over an extended period of time, attach the lens cap. To prevent loss for the lens cap, please according to the following procedures, attach the lens cap with the string of accessories.

- 1) Thread the thinner end of the string through the hole on the lens cap.

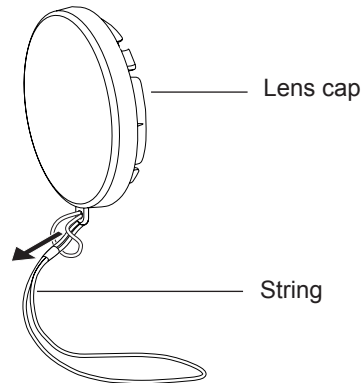

- 2) Thread the other end of the string through the hole on the bottom of the projector.

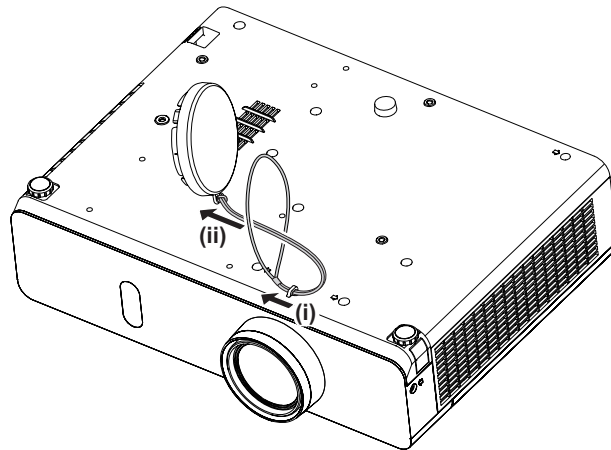



# Chapter 2 Getting Started

---

This chapter describes things you need to do before using the projector such as the setup and connections.

# Setting up

## Installation mode

There are four ways to set up the projector. Set the [PROJECTOR SETUP] menu → [PROJECTION METHOD] (➔ page 70) depending on the installation location.

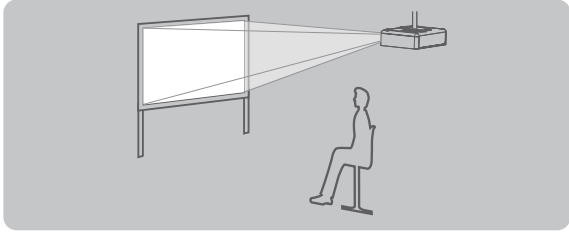
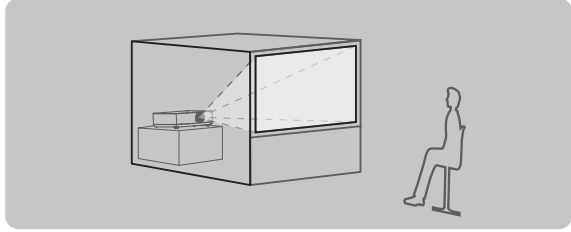
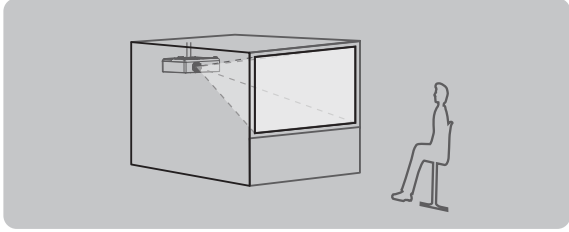
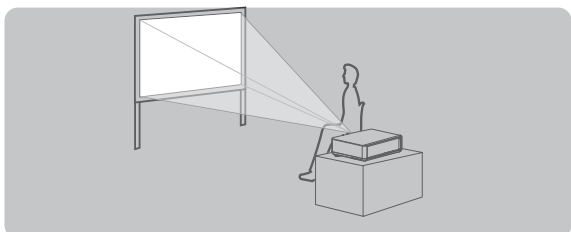
<b>Mounting on the ceiling and projecting forward</b> 		<b>Setting on a desk/floor and projecting from rear</b> (Using the translucent screen) 	
<b>Menu item</b>	<b>Method</b>	<b>Menu item</b>	<b>Method</b>
[PROJECTION METHOD]	[FRONT/CEILING]	[PROJECTION METHOD]	[REAR/DESK]
<b>Mounting on the ceiling and projecting from rear</b> (Using the translucent screen) 		<b>Setting on a desk/floor and projecting forward</b> 	
<b>Menu item</b>	<b>Method</b>	<b>Menu item</b>	<b>Method</b>
[PROJECTION METHOD]	[REAR/CEILING]	[PROJECTION METHOD]	[FRONT/DESK]

## Parts for ceiling mount (optional)

This requires an optional ceiling mount bracket. Be sure to use the Projector Mount Bracket together with the ceiling mount bracket for high ceilings or low ceilings.

Model No.:

- ① ET-PKL100H (for high ceilings), ET-PKV400B (Projector Mount Bracket)
- ② ET-PKL100S (for low ceilings), ET-PKV400B (Projector Mount Bracket)

- Use only the ceiling mount brackets specified for this projector.
- Refer to the Installation Instructions for the ceiling mount bracket when you install the bracket and the projector.

### Attention

- To ensure projector performance and security, installation of the ceiling mount bracket must be carried by your dealer or a qualified technician.

## Screen size and throw distance

Refer to the screen size and projection distances to install the projector. Image size and image position can be adjusted in accordance with the screen size and screen position.

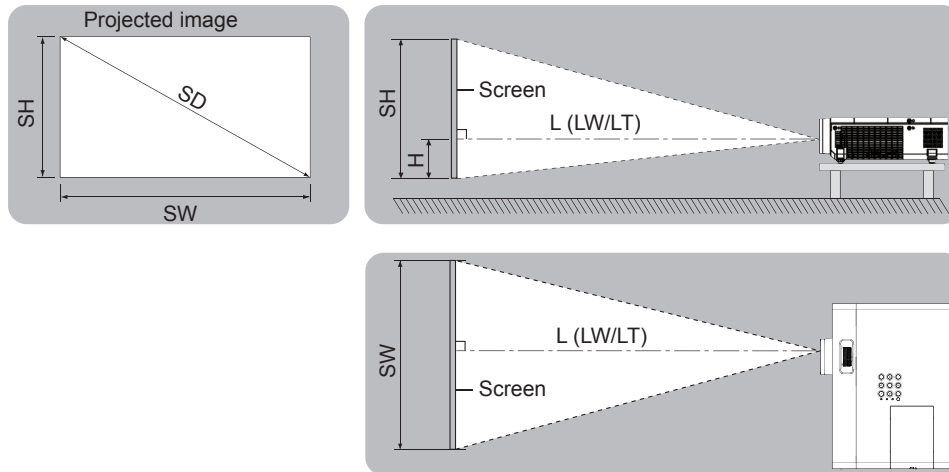

L (LW/LT) *1	Projection distance (m)
SH	Image height (m)
SW	Image width (m)
H	Distance from the center of lens to the image lower end (m)
SD	Projected image size (m)

\*1 LW : Minimum distance  
LT : Maximum distance

### Attention

- Before installing, please read “Precautions for Use” (➔ page 14).

### Projection distance

#### For PT-VW350

All measurements below are approximate and may differ slightly from the actual measurements. (Unit: m)

Projection size	For 4:3 aspect ratio			For 16:9 aspect ratio			For 16:10 aspect ratio		
	Screen diagonal (SD)	Minimum distance (LW)	Maximum distance (LT)	Height position (H)	Minimum distance (LW)	Maximum distance (LT)	Height position (H)	Minimum distance (LW)	Maximum distance (LT)
0.76 (30")	0.83	1.37	0.009	0.76	1.24	-0.012	0.73	1.21	0.008
1.02 (40")	1.13	1.85	0.012	1.02	1.68	-0.017	0.99	1.63	0.011
1.27 (50")	1.41	2.31	0.015	1.28	2.09	-0.021	1.25	2.04	0.013
1.52 (60")	1.70	2.77	0.018	1.54	2.51	-0.025	1.50	2.44	0.016
1.78 (70")	1.99	3.25	0.021	1.81	2.95	-0.029	1.76	2.87	0.019
2.03 (80")	2.28	3.71	0.024	2.07	3.37	-0.033	2.01	3.27	0.022
2.29 (90")	2.57	4.19	0.027	2.33	3.80	-0.037	2.27	3.70	0.024
2.54 (100")	2.86	4.65	0.030	2.59	4.22	-0.041	2.52	4.10	0.027
3.05 (120")	3.44	5.59	0.037	3.12	5.07	-0.050	3.03	4.93	0.032
3.81 (150")	4.30	6.99	0.046	3.90	6.34	-0.062	3.80	6.17	0.040
5.08 (200")	5.74	9.33	0.061	5.21	8.47	-0.083	5.07	8.24	0.054
6.35 (250")	7.19	11.67	0.076	6.52	10.59	-0.104	6.34	10.30	0.067
7.62 (300")	8.63	14.01	0.091	7.82	12.72	-0.124	7.62	12.37	0.081

**For PT-VX420**

All measurements below are approximate and may differ slightly from the actual measurements. (Unit: m)

Projection size	For 4:3 aspect ratio			For 16:9 aspect ratio		
	Minimum distance (LW)	Maximum distance (LT)	Height position (H)	Minimum distance (LW)	Maximum distance (LT)	Height position (H)
0.76 (30")	0.69	1.14	0.046	0.75	1.24	-0.012
1.02 (40")	0.94	1.54	0.061	1.02	1.68	-0.017
1.27 (50")	1.17	1.92	0.076	1.28	2.09	-0.021
1.52 (60")	1.41	2.30	0.091	1.54	2.51	-0.025
1.78 (70")	1.65	2.70	0.107	1.81	2.94	-0.029
2.03 (80")	1.89	3.08	0.122	2.06	3.36	-0.033
2.29 (90")	2.14	3.48	0.137	2.33	3.80	-0.037
2.54 (100")	2.37	3.87	0.152	2.59	4.21	-0.041
3.05 (120")	2.86	4.65	0.183	3.11	5.07	-0.050
3.81 (150")	3.58	5.81	0.229	3.90	6.33	-0.062
5.08 (200")	4.78	7.76	0.305	5.21	8.45	-0.083
6.35 (250")	5.98	9.70	0.381	6.52	10.57	-0.104
7.62 (300")	7.18	11.65	0.457	7.82	12.70	-0.124

**Projection distance formulas**

Any other projection distance can be obtained according to the screen dimensions (m) by using the following calculations. The calculated distance may contain a certain error.

If you want to calculate the projection distance with projected image size SD (unit: inch) by substituting, please assign 0.0254 times to the SD value.

**For PT-VW350**

	For 4:3 aspect ratio	For 16:9 aspect ratio	For 16:10 aspect ratio
<b>Screen height (SH)</b>	= 0.6 × SD(m)	= 0.490 × SD(m)	= 0.530 × SD(m)
<b>Screen width (SW)</b>	= 0.8 × SD(m)	= 0.872 × SD(m)	= 0.848 × SD(m)
<b>Minimum distance (LW)</b>	= 1.1363 × SD(m) - 0.0290	= 1.0316 × SD(m) - 0.0290	= 1.0037 × SD(m) - 0.0290
<b>Maximum distance (LT)</b>	= 1.8422 × SD(m) - 0.0292	= 1.6725 × SD(m) - 0.0292	= 1.6273 × SD(m) - 0.0292

**For PT-VX420**

	For 4:3 aspect ratio	For 16:9 aspect ratio
<b>Screen height (SH)</b>	= 0.6 × SD(m)	= 0.490 × SD(m)
<b>Screen width (SW)</b>	= 0.8 × SD(m)	= 0.872 × SD(m)
<b>Minimum distance (LW)</b>	= 0.9461 × SD(m) - 0.0295	= 1.0307 × SD(m) - 0.0295
<b>Maximum distance (LT)</b>	= 1.5324 × SD(m) - 0.0272	= 1.6696 × SD(m) - 0.0272

## Adjusting adjustable feet

---

Lift the front of the projector and press the feet lock latches on both side of the projector.

Release the feet lock latches to lock the adjustable feet and rotate the adjustable feet to a proper height and tilt.

Extend the adjustable feet by rotating in the direction shown in the figure and retract by rotating in the opposite direction.

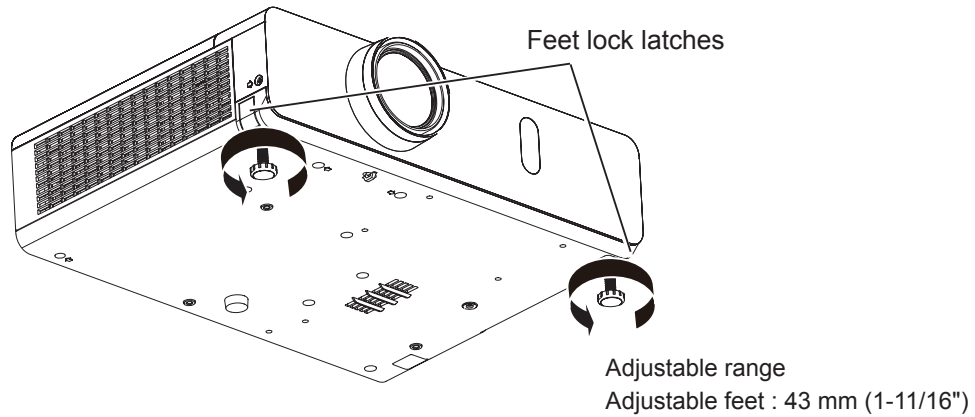

---

### Attention

---

- Heated air comes out of the air exhaust port while the lamp is lit. Do not touch the air exhaust port directly when you adjust the adjustable feet.
- If keystone distortion occurs on the projected image, perform [KEystone] from the [POSITION] menu. (➔ page 56)

---

### Note

---

- Screw up the adjustable feet, and an audible click will be heard as the limit.

# Connecting

## Before connecting

- Before connecting, carefully read the operating instructions for the external device to be connected.
- Turn off the power switch of the devices before connecting cables.
- Take note of the following points before connecting the cables. Failure to do so may result in malfunctions.
  - When connecting a cable to a device connected to the projector or the projector itself, touch any nearby metallic objects to eliminate static electricity from your body before performing work.
  - Do not use unnecessarily long cables to connect to a device connected to the projector or to the projector body. The longer the cable, the more it is susceptible to noise. Since using a cable while it is wound makes it act like an antenna, it is more susceptible to noise.
  - When connecting cables, connect GND first, then insert the connecting terminal of the connecting device in a straight manner.
- If any connection cable is not supplied with the device, or if no optional cable is available for connection of the device, prepare a necessary system connection cable to suit the device.
- Video signals containing too much jitter may cause the images on the screen to randomly wobble or wafture. In this case, a time base corrector (TBC) must be connected.
- The projector accepts VIDEO signals, S-VIDEO signals, YC<sub>B</sub>C<sub>R</sub>/YP<sub>B</sub>P<sub>R</sub> signals and analog RGB signals (synchronous signals are TTL level), and digital signal.
- Some computer models or graphics cards are not compatible with the projector.
- When using long cables to connect with each of equipment to the projector, there is a possibility that the image will not be output correctly unless a compensator is used.
- For details on what video signals the projector supports, see "List of compatible signals". (➔ page 112)

## <S-VIDEO IN> terminal pin assignments and signal names

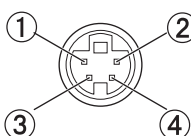
Outside view	Pin No.	Signal names
	①	GND (luminance signal)
	②	GND (color signal)
	③	Luminance signal
	④	Color signal

## <COMPUTER 1 IN> terminal pin assignments and signal names

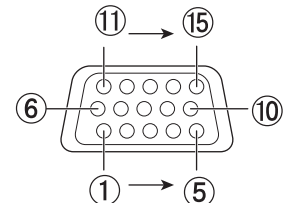
Outside view	Pin No.	Signal names	Pin No.	Signal names
	①	R/P <sub>R</sub>	⑨	+ 5 V
	②	G/Y	⑩	GND
	③	B/P <sub>B</sub>	⑪	GND
	④	—	⑫	DDC data
	⑤	GND	⑬	HD/SYNC
	⑥	GND	⑭	VD
	⑦	GND	⑮	DDC clock
	⑧	GND		

**<COMPUTER 2 IN/1 OUT> terminal pin assignments and signal names**

Outside view	Pin No.	Signal names	Pin No.	Signal names
	①	R/P <sub>R</sub> *1	⑨	+5 V
	②	G/Y*1	⑩	GND
	③	B/P <sub>B</sub> *1	⑪	—
	④	—	⑫	DDC data
	⑤	GND	⑬	HD/SYNC
	⑥	GND	⑭	VD
	⑦	GND	⑮	DDC clock
	⑧	GND		

\*1: It is only for RGB signals when the terminal is used as the input terminal.

**<HDMI IN> terminal pin assignments and signal names**

Outside view	Pin No.	Signal names	Pin No.	Signal names
<p>Even-numbered pins ② to ⑱</p> <p>Odd-numbered pins ① to ⑲</p>	①	T.M.D.S data 2+	⑪	T.M.D.S clock shield
	②	T.M.D.S data 2 shield	⑫	T.M.D.S clock -
	③	T.M.D.S data 2-	⑬	CEC
	④	T.M.D.S data 1+	⑭	—
	⑤	T.M.D.S data 1 shield	⑮	SCL
	⑥	T.M.D.S data 1-	⑯	SDA
	⑦	T.M.D.S data 0+	⑰	DDC/CEC GND
	⑧	T.M.D.S data 0 shield	⑱	+5 V
	⑨	T.M.D.S data 0-		Hot plug detection
	⑩	T.M.D.S clock +		

## Connecting example : AV equipment

### For <HDMI IN>/<VIDEO IN>/<S-VIDEO IN> terminals

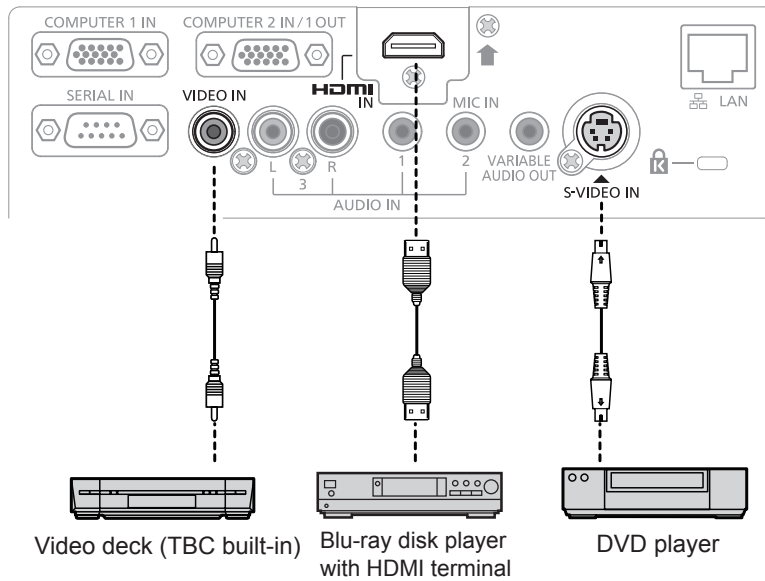

### Attention

- Always use one of the following when connecting a VCR.
  - A VCR with built-in time base corrector (TBC).
  - A time base corrector (TBC) between the projector and the VCR.
- If nonstandard burst signals are connected, the image may be distorted. In such case, connect the time base corrector (TBC) between the projector and the external devices.

### Note

- For an HDMI cable, use an HDMI High Speed cable that conforms to HDMI standards. If a cable that does not conform to HDMI standards is used, images may be interrupted or may not be displayed.
- This projector does not support the Viera link (HDMI).

## Connecting example : Computers

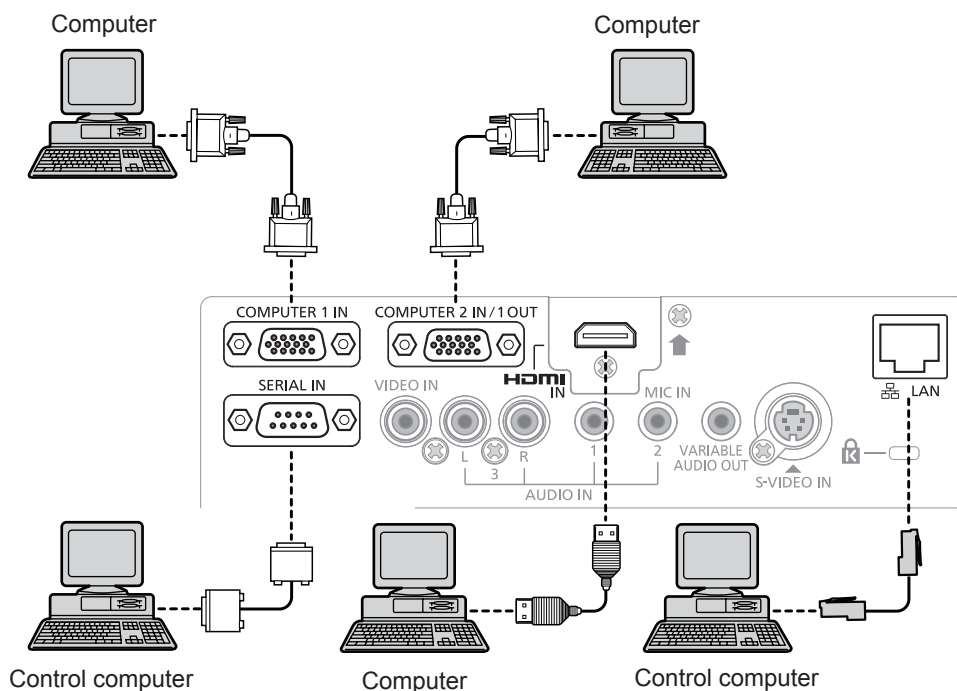



### Attention

- When connecting the projector to a computer or an external device, use the power cord supplied with each device and commercially available shielded cables.

### Note

- If you operate the projector using the computer with the resume feature (last memory), you may have to reset the resume feature to operate the projector.

### Connecting example : Audio

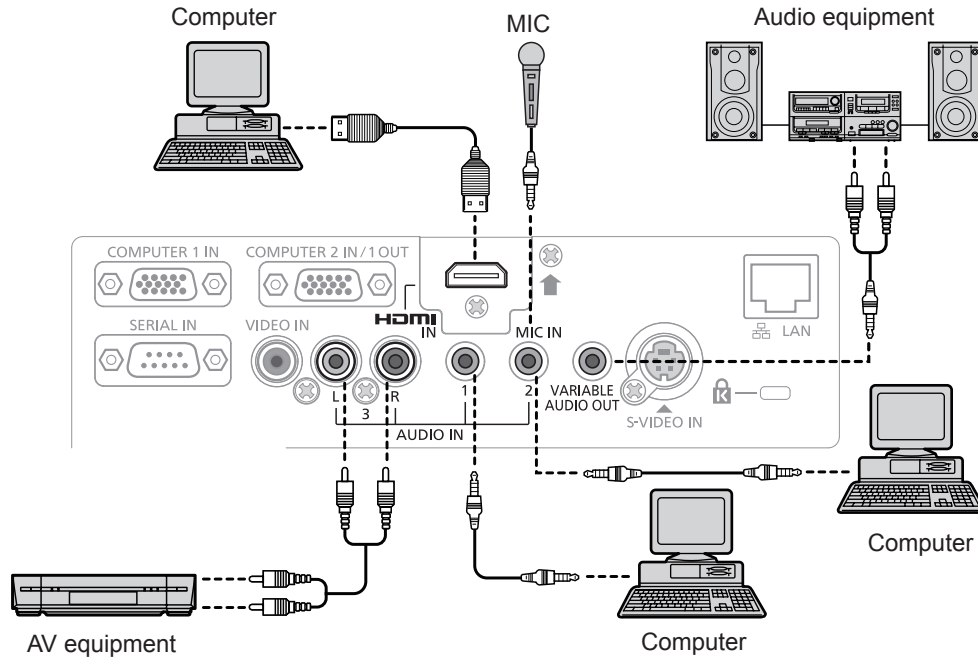

### Note

- If the [AUDIO IN SELECT] settings are incorrect, the projector may have malfunctions such as the absence of audio. (➔ page 74)
- When the <VARIABLE AUDIO OUT> terminal is connected with cable, the sound will not be output from the built-in speaker.

# Chapter 3 Basic Operations

---

This chapter describes basic operations to start with.

# Powering on/off

## Connecting the power cord

Make sure that the supplied power cord is securely fixed to the projector body to prevent it from being removed easily.

For details of power cord handling, refer to "Read this first!" (➔ page 2).

### Attaching

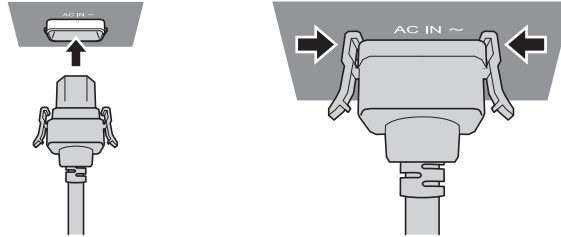

- 1) Check the shapes of the <AC IN> terminal on the back of the projector body and the power cord connector and insert the plug completely in the correct direction (until you hear the side tabs click in place).

### Removing

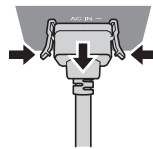

- 1) Confirm that the projector is in standby mode, and remove the power plug from the outlet.
- 2) Remove the power cord connector from the <AC IN> terminal of the projector body while pressing the side tabs.

## Power indicator

The power indicator <ON(G)/STANDBY(R)> informs you the status of the power. Confirm the status of the power indicator <ON(G)/STANDBY(R)> before operating the projector.

Power indicator <ON(G)/STANDBY(R)>

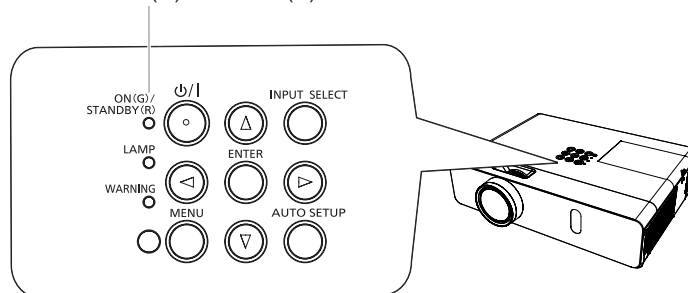

Indicator status		Status
Off		The power cord is unplugged.
Red	Lit	The power is switched off (in standby mode). The [PROJECTOR SETUP] menu ➔ [ECO MANAGEMENT] ➔ [STANDBY MODE] is set to [ECO].
	Blinking	The power is switched off (in standby mode). The [PROJECTOR SETUP] menu ➔ [ECO MANAGEMENT] ➔ [STANDBY MODE] is set to [NETWORK].*1 The power is switched off (in standby mode). The [PROJECTOR SETUP] menu ➔ [ECO MANAGEMENT] ➔ [STANDBY MODE] is set to [NORMAL].*2
Orange	Lit	The projector is cooling down. The power is switched off after a while. (Changes to the standby mode.)

Indicator status		Status
Green	Lit	Projecting.
	Blinking	The power is on and the lamp is not working. The [PROJECTOR SETUP] menu → [ECO MANAGEMENT] → [POWER MANAGEMENT] is set to [READY].*3
		The lamp starts work. The projector will project image after a while.*4

\*1: The indicator will light as the following order:

2.75 seconds (light) → 0.25 seconds (off) → 0.75 seconds (light) → 0.25 seconds (off)

\*2: The indicator will light as the following order:

2.75 seconds (light) → 0.25 seconds (off)

\*3: The indicator will light as the following order:

2.0 seconds (light) → 2.0 seconds (off)

\*4: The indicator will light as the following order:

0.5 seconds (light) → 0.5 seconds (off)

### Powering On the Projector

Before switching on the projector, make sure all the other devices are correctly connected (➔ page 32) and remove the lens cap.

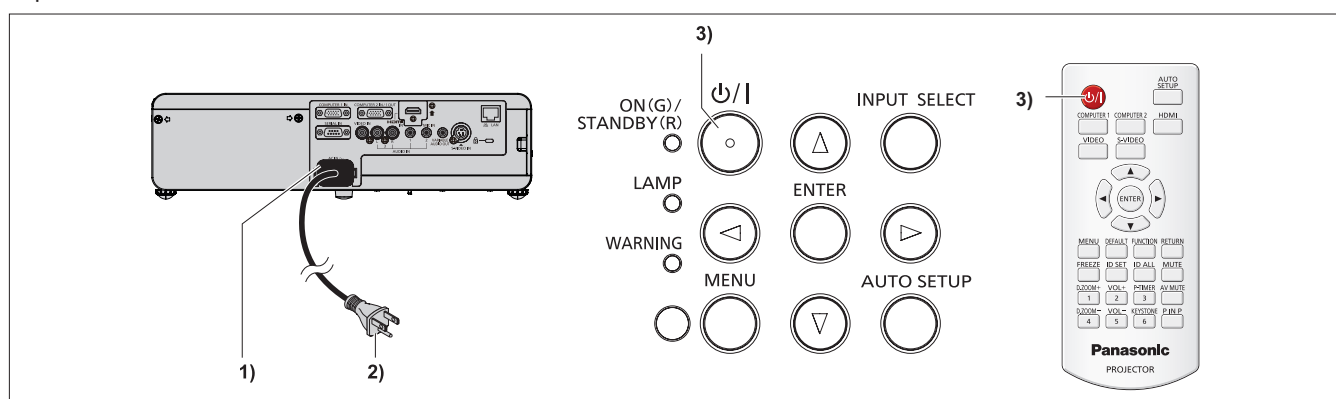

**1) Connect the power cord to the projector body.**

**2) Connect the power plug to an outlet.**

- The power indicator <ON(G)/STANDBY(R)> lights or blinks, and the projector will enter the standby mode.

**3) Press the power <⏻/|> button on the control panel or on the remote control.**

- The power indicator <ON(G)/STANDBY(R)> lights in green and the image is soon projected on the screen.

#### Attention

- Be sure to remove the lens cap before starting projection.

#### Note

- If the [PROJECTOR SETUP] menu → [ECO MANAGEMENT] → [STANDBY MODE] is set to [ECO], it may take approx. 10 seconds longer before the projector starts projecting after the power is turned on, compared with when [NORMAL] is set.

### When the initial setting screen is displayed

When the projector is switched on for the first time after purchase as well as when [INITIALIZE ALL] in the [PROJECTOR SETUP] menu is executed, then the initial setting screen is displayed. Set them in accordance with circumstances.

In other occasions, you can change the settings by menu operations.

#### Initial setting (display language)

Select the language to show on the screen.

After completed the initial setting, you can change the display language from the [LANGUAGE] menu.

- 1) Press ▲▼◀▶ to select the display language.



- 2) Press the <ENTER> button to proceed to the initial setting.

### Initial setting (installation setting)

Set each item.



- 1) Press ▲▼ to select an item.

Item	Description	Page
[PROJECTION METHOD]	Set [PROJECTION METHOD] depending on the installation mode. After completed the initial setting, you can change the setting from the [PROJECTOR SETUP] menu → [PROJECTION METHOD].	70
[SCREEN FORMAT]*1	Set the screen format (aspect ratio) and display position of the image. After completed the initial setting, you can change the settings of each item from the [DISPLAY OPTION] menu → [SCREEN SETTING].	64
[SCREEN POSITION]*1	Set the display position of the image. After completed the initial setting, you can change the settings of each item from the [DISPLAY OPTION] menu → [SCREEN SETTING].	64
[HIGH ALTITUDE MODE]	Change the setting when the projector is used at high altitude. Set it to [OFF] when using the projector at altitude lower than 1 400 m (4 593'), set it to [HIGH1] when using the projector at altitude between 1 400 m (4 593') and 2 000 m (6 562') above sea level, and set it to [HIGH2] when using the projector at altitude between 2 000 m (6 562') and 2 700 m (8 858') above sea level.	70

\*1 Only for PT-VW350.

- 2) Press ◀▶ to switch the setting.
- 3) Press the <ENTER> button to perform next initial setting.

Initial setting (standby mode)

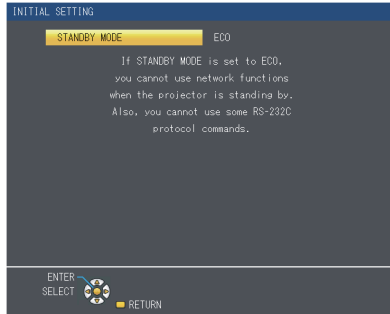

Item	Description	Page
[STANDBY MODE]	<p>Set the operation mode during standby.</p> <ul style="list-style-type: none"> <li>• The default setting is [ECO] that keeps power consumption low during standby.</li> <li>• Set to [NORMAL] to use the network function or the serial communication function during standby.</li> <li>• Set to [NETWORK] to reduce power consumption during standby, and to operate the projector via the wired LAN or the serial communication function by using the Wake on LAN function.</li> </ul> <p>After completed the initial setting, you can change the setting from the [PROJECTOR SETUP] menu → [ECO MANAGEMENT] → [STANDBY MODE].</p>	72

- 1) Press ◀▶ to switch the setting.
- 2) Press the <ENTER> button.
  - Confirm the setting value and complete the initial setting.

Note

- If you press the <RETURN> button while the initial setting screen is displayed, you can go back to the previous screen.
- The above initial setting screen is the one displayed when the projector is switched on for the first time after purchase. When [PROJECTOR SETUP] menu → [INITIALIZE ALL] is executed, the setting of [STANDBY MODE] before execution is displayed.

Making adjustments and selections

It is recommended that images are projected continuously for at least 30 minutes before the focus is adjusted.

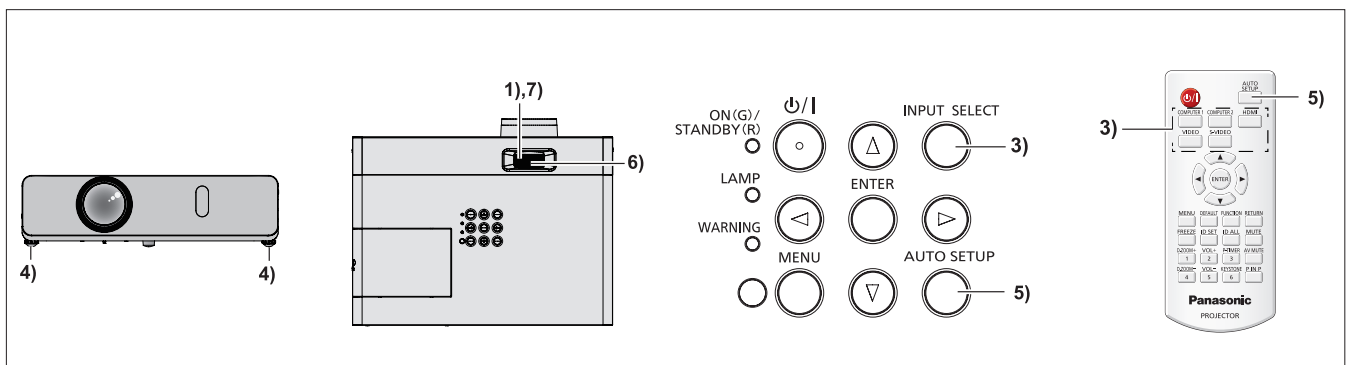

- 1) Adjust the focus of the image roughly. (➡ page 40)
- 2) Change the settings of the [PROJECTOR SETUP] menu → [PROJECTION METHOD] depending on the installation mode. (➡ page 70)
  - Refer to “Navigating through the menu” (➡ page 47) for the operation of the menu screen.
- 3) Press the <INPUT SELECT> button on the control panel or the input selection (<COMPUTER 1>, <COMPUTER 2>, <HDMI>, <VIDEO>, <S-VIDEO>) buttons on the remote control to select the input signal.
- 4) Adjust the front, back and sideways tilt of the projector with the adjustable feet. (➡ page 29)
- 5) If the input signal is an analog RGB signal, press the <AUTO SETUP> button.

6) Adjust the size of the image to match the screen with the zoom ring.

7) Adjust the focus with the focus ring.

**Note**

- When the projector is switched on for the first time after purchase as well as when the [PROJECTOR SETUP] menu → [INITIALIZE ALL] is executed, the initial setting screen is displayed after projection starts.

**Powering Off the Projector**

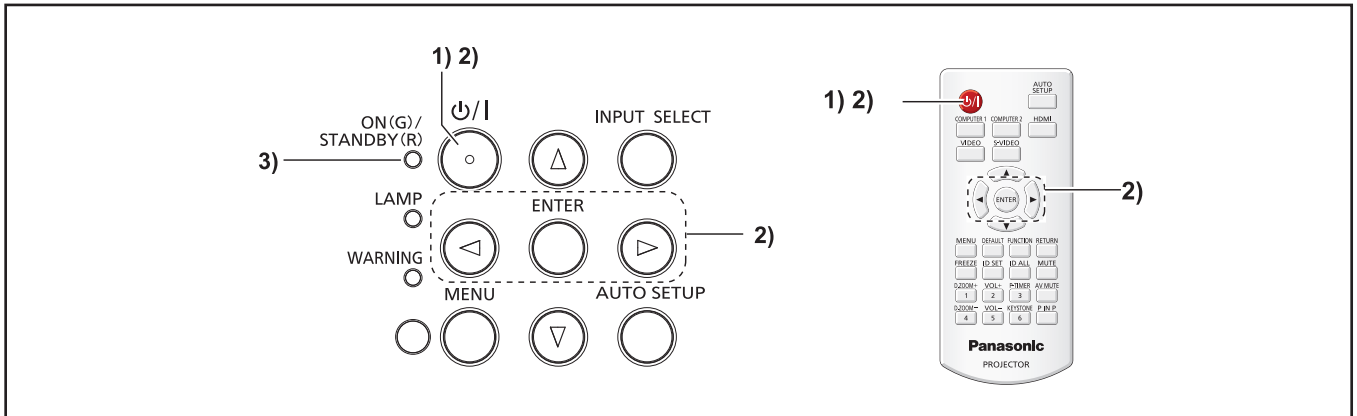

1) Press the power <⏻/⏿> button on the control panel or on the remote control.

- The following message appears.

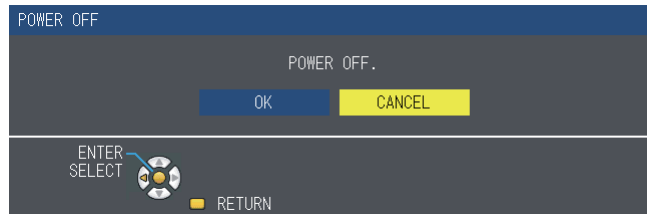

2) Press ◀▶ to select [OK], and press the <ENTER> button.  
(Or press the power <⏻/⏿> button on the control panel or on the remote control again.)

- Projection of the image will stop, and the power indicator <ON(G)/STANDBY(R)> lights in orange. (The fans keep running.)

3) Wait until the power indicator <ON(G)/STANDBY(R)> lights or blinks in red.

- The projector enters standby mode when the power indicator <ON(G)/STANDBY(R)> lights or blinks in red.

**Note**

- While the power indicator <ON(G)/STANDBY(R)> is lighting in orange, the lamp is being cooled down and the projector cannot be turned on. Wait until the power indicator <ON(G)/STANDBY(R)> starts lighting or blinking in red to turn on the projector again.
- When packing the projector for transportation and storage, please make sure that each indicator is off.

**Direct Power Off function**

You can disconnect the power cord from the wall outlet or turn off the power breaker switch even during projection.

**Attention**

- Do not disconnect the power cord from the wall outlet or turn off the power breaker switch in a short time (about 1 minute) after the lamp is lit. Doing so may cause the lamp fail to light while you powering on the projector next time, or result in premature deterioration of the lamp.

**Note**

- When using the Direct Power Off function, you cannot restart the projector immediately after disconnecting the power cord from the wall outlet or turning off the power breaker switch. The lamp remains high temperature and needs to cool down, so it sometimes takes a longer time than usual for the lamp to light up again.

# Projecting

Check the connections of the peripheral devices (➔ page 30) and connection of the power cord (➔ page 34) and switch on the power (➔ page 36) to start the projector. Select the image and adjust the state of the image.

## Selecting the input signal

Select an input signal.

- 1) Press the <COMPUTER 1>, <COMPUTER 2>, <HDMI>, <VIDEO> or <S-VIDEO> button on the remote control or <INPUT SELECT> button on the control panel.
  - The image of the signal being input in the selected terminal is projected.
  - You can check the input source through [DETAILED] / [SIMPLE] under the [DISPLAY OPTION] → [ON-SCREEN DISPLAY] → [INPUT GUIDE] menu.
  - You can also select the input source by pressing ▲▼◀▶ on the [DETAILED] screen.

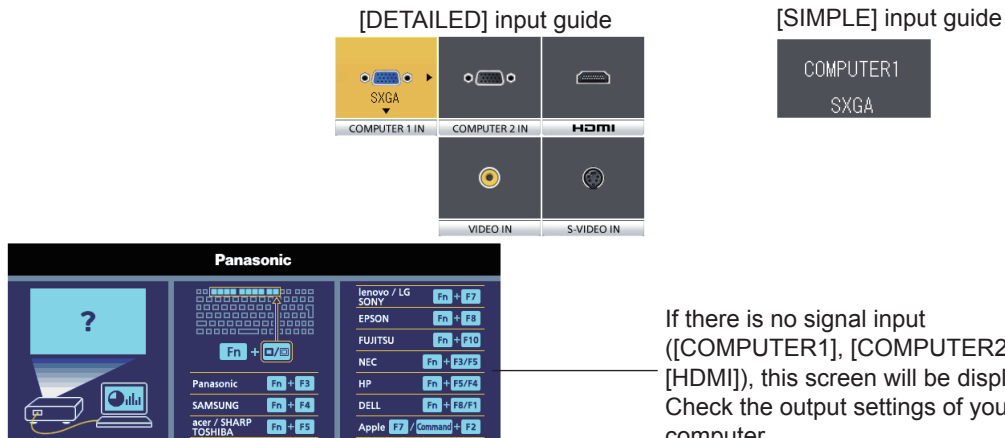

If there is no signal input ([COMPUTER1], [COMPUTER2] or [HDMI]), this screen will be displayed. Check the output settings of your computer.

### Attention

- Images may not be projected properly depending on the connected device and DVD, video tape, etc. to be played. Set the [PICTURE] menu → [RGB/YC<sub>B</sub>C<sub>R</sub>] or [RGB/YP<sub>B</sub>P<sub>R</sub>] (➔ page 55).
- Check the aspect ratio of the screen and the image and select the optimum aspect ratio under the [POSITION] menu (➔ page 59).

## How to adjust the state of the image

If the projected image or the position is not correct when the positioning of the projector and the screen is correctly installed, adjust the focus and zoom.

- 1) Adjust the projection angle.
  - Install the projector on a flat surface and parallel to the screen so that the projected screen is rectangular.
  - If the screen is tilted downward, extend the adjustable feet and adjust the projection screen so that the projected screen is rectangular.
  - For details, see “Adjusting adjustable feet” (➔ page 29).
- 2) Adjust the zoom and the focus.
  - Rotate the zoom ring to zoom in and out the image.
  - Rotate the focus ring to adjust the focus of the projected image.

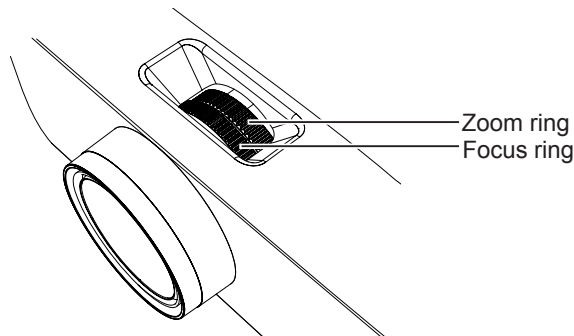

### Note

- It is recommended that the images are projected continuously for at least 30 minutes before the focus is adjusted.
- If you adjust the focus, you may need to adjust the size of the image by turning the zoom ring again.
- If keystone distortion occurs, see the [POSITION] menu → [KEystone] (➔ page 56).



# Basic operations by using the remote control

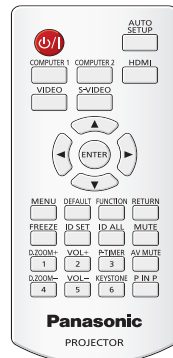

## Using the AUTO SETUP function

The automatic setup function can be used to automatically adjust the resolution, clock phase, and image position when analog RGB signals consisting of bitmap images such as computer signals are being input. Supplying images with bright white borders at the edges and high-contrast black and white characters is recommended when the system is in automatic adjustment mode.

Avoid supplying images that include halftones or gradation, such as photographs and computer graphics.

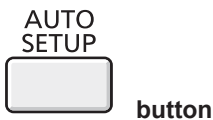

- 1) Press the <AUTO SETUP> button on the remote control.

### Note

- The [CLOCK PHASE] may shift even if it has completed without any incident. In such cases, adjust the [POSITION] menu → [CLOCK PHASE] (➔ page 58).
- Automatic adjustment may not work depending on the model of the computer and the input signal.
- Images may be disrupted for a few seconds during automatic adjustment, but it is not a malfunction.
- If you press any button on the remote control during the automatic adjustment, the automatic adjustment will be canceled.
- If the automatic setup function is used while moving images are being input, the adjustment may not be performed properly even for an RGB signal that can use automatic setup.

## Using the KEYSTONE button

You can correct the trapezoidal distortion that occurs when the projector is installed tilted or when the screen is tilted.



- 1) Press the <KEYSTONE> button to select [KEYSTONE] or press the <KEYSTONE> button again to select [CORNER CORRECTION].
  - The [KEYSTONE] or [CORNER CORRECTION] individual adjustment screen is displayed.
- 2) Press ▲▼◀▶ to adjust the item.

### Note

- For more details, refer to the [POSITION] menu → [KEYSTONE] (➔ page 56).

## Switching the input signal

You can switch the input signals to project.

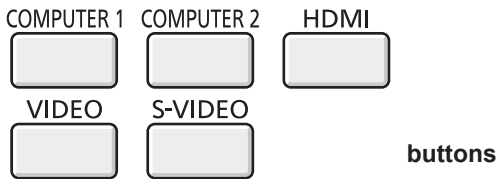

1) Press the <COMPUTER 1>, <COMPUTER 2>, <HDMI>, <VIDEO> or <S-VIDEO> button on the remote control.

- This operation can be also performed using the <INPUT SELECT> button on the control panel.

<COMPUTER 1>	Switch to COMPUTER1 input.
<COMPUTER 2>	Switch to COMPUTER2 input.
<HDMI>	Switch to HDMI input.
<VIDEO>	Switch to VIDEO input.
<S-VIDEO>	Switch to S-VIDEO input.

## Using the FUNCTION button

Some operations in the menu can be assigned to the <FUNCTION> button on the remote control so that it can be used as an easy shortcut button.



1) Press the <FUNCTION> button on the remote control.

### To assign functions to the <FUNCTION> button

1) Press the <MENU> button on the control panel or on the remote control to display the menu items (main menu, sub-menu or details menu) you want to assign.

- Refer to “Navigating through the menu” (➔ page 47) for the operation of the on-screen menu.

2) Press and hold the <FUNCTION> button for 3 seconds or more.

#### Note

- After settings have been completed, the assigned menu item (main menu, sub-menu or details menu) will be displayed in [ASSIGNED FUNCTION] of the operation guide under the menu.
- Perform the [PROJECTOR SETUP] menu → [FUNCTION BUTTON] (➔ page 73) when deallocating functions.

## Using the FREEZE function

You can freeze the projected image and stop the sound temporarily, regardless of the playing condition of the external device.



1) Press the <FREEZE> button on the remote control.

- The video is paused and the audio is muted. [FREEZE] is displayed on the lower left of the screen during FREEZE.

2) Press the <FREEZE> button again.

- The video playback resumes and the audio is unmuted.

#### Note

- When no signal input, [KEY NOT APPLICABLE] message will appear.
- When [MIC] is set to [ON], the audio of MIC can be output even during FREEZE.

## Using the AV MUTE function

If the projector is not used for a certain period of time during the meeting intermission, for example, it is possible to turn off the audio and image temporarily.



- 1) **Press the <AV MUTE> button on the remote control.**
  - The audio and image turn off.
- 2) **Press the <AV MUTE> button again.**
  - The audio and image turn on.

### Note

- When [MIC] is set to [ON], the audio of MIC can be output even during AV MUTE.

## Using the P-TIMER function

You can operate the presentation timer function.

Presentations, etc. can be performed while checking the elapsed time or time remaining in the preset time.



- 1) **Press the <P-TIMER> button on the remote control.**
  - The count is started.
  - The elapsed time or the remaining time is displayed at the bottom right of the projected image.
- 2) **Press the <P-TIMER> button again.**
  - The count is stopped.
- 3) **Press the <P-TIMER> button again.**
  - The count is resumed.

### Note

- Pressing the <P-TIMER> button for at least 3 seconds to release the P-TIMER function.
- For details, please refer to the [DISPLAY OPTION] menu → [P-TIMER] (➡ page 66).

## Using the DIGITAL ZOOM function

(Only for still image-based computer (RGB) and still image-based HDMI signals input)

You can enlarge the center area. You can also change the location of the area to be enlarged.

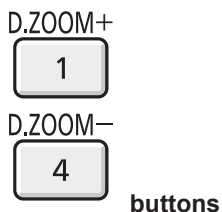

- 1) **Press the <D.ZOOM +> button or <D.ZOOM -> button on the remote control.**
  - The moving screen is displayed.
  - The [DIGITAL ZOOM] individual adjustment screen is displayed when executing the menu operation. For details, refer to [DISPLAY OPTION] → [OTHER FUNCTIONS] (➡ page 67).
  - You can press the <RETURN> button to cancel the function.

### ■ Button functions during [DIGITAL ZOOM]

Operation menu	Operation	Adjustment	Adjustment range
	Press the <D.ZOOM +> button or ► button.	Increases magnification.	1.0 ~ 3.0
	Press the <D.ZOOM -> button or ◀ button.	Decreases magnification.	

■ Button functions of moving screen

Operation menu	Operation	Adjustment
	Press the ▲ button.	The display position moves down.
	Press the ▼ button.	The display position moves up.
	Press the ◀ button.	The display position moves right.
	Press the ▶ button.	The display position moves left.

- When you have executed the operation of remote control directly, the individual adjustment screen is not displayed and the operation menu of the moving screen is displayed. At this time, you can adjust the magnification by using the <D.ZOOM +> button or <D.ZOOM -> button on the remote control.

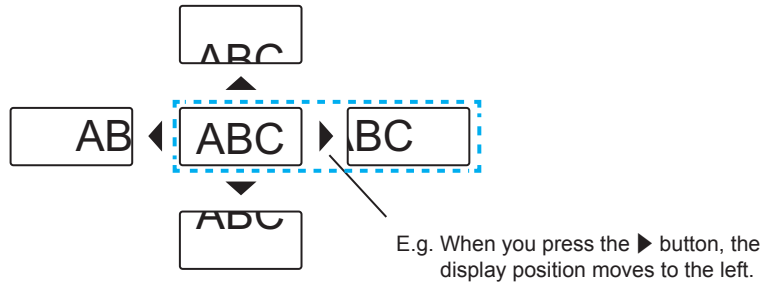

**Note**

- Magnification can be set from 1.0x to 3.0x in 0.1 increments.
- When press the <MENU> button during [DIGITAL ZOOM], the adjustment value of DIGITAL ZOOM will be cancelled.
- When the input signals change during [DIGITAL ZOOM], the adjustment value of DIGITAL ZOOM will be cancelled.
- When [DIGITAL ZOOM] is active, the FREEZE function is not available.
- The digital zoom function may not work properly for some still image-based signals.

**Controlling the volume of the speaker**

You can control the volume of the projector’s speaker or audio output.

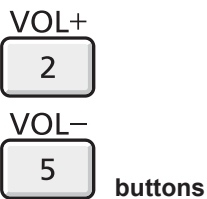

- 1) Press the <VOL -> button or <VOL +> button on the remote control.

- This operation can be also performed using the ◀▶ buttons on the control panel.

<VOL +>	Increases the volume.
<VOL ->	Decreases the volume.

**Using the MUTE function**

This function allows you to turn off the audio output temporarily.



- 1) Press the <MUTE> button on the remote control.

- The audio turns off.

- 2) Press the <MUTE> button again.

- The audio turns on.

## Using the P IN P function

(Only for PT-VW350)

Two images can be projected simultaneously in form of projection mode (a small sub screen in the main screen [P IN P] / a small sub screen side by side with the main screen [SIDE BY SIDE]).



### 1) Press the <P IN P> button on the remote control.

- Press this button to switch the mode ([P IN P]/[SIDE BY SIDE]).

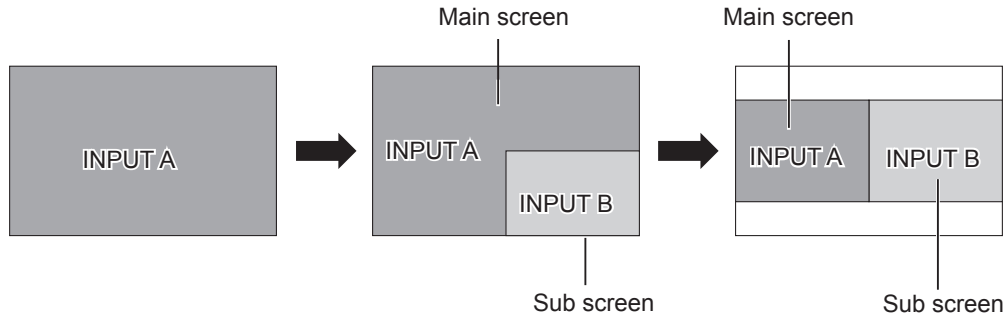

### Note

- For details, refer to [P IN P] (➔ page 67).

## Switch the input source

You can switch the input source of the main screen and sub screen while the P IN P function is operating.

### ■ Switch the input source of the main screen

Switch the input source as the same operation as the single screen.

### ■ Switch the input source of the sub screen

When two screens are displayed (when no menu is displayed), press the <ENTER> button, the red frame of the sub screen will be displayed. Switch the input source as the same operation as the single screen.

Press the <ENTER> button again, the red frame of the sub screen will disappear and then return to switch the input source of the main screen.

## Setting the ID number of the remote control

When you use the system with multiple projectors, you can operate all the projectors simultaneously or each projector individually by using single remote control, if unique ID number is assigned to each projector.

After setting the ID number of the projector, set the same ID number to the remote control.

The factory default ID number of the projector is set to [ALL]. When using a single projector, press the <ID ALL> button on the remote control. Also, you can control a projector by pressing the <ID ALL> button on the remote control even if you do not know the projector ID.



### 1) Press the <ID SET> button on the remote control.

### 2) Within five seconds, press the one-digit ID number set on the projector using the number (<1> - <6>) buttons.

- If you press the <ID ALL> button, you can control the projectors regardless of the ID number setting of the projector.

### Attention

- Since the ID number of the remote control can be set without the projector, do not press the <ID SET> button on the remote control carelessly. If the <ID SET> button is pressed and no number (<1> - <6>) buttons are pressed within five seconds, the ID number returns to its original value before the <ID SET> button was pressed.
- The ID number set on the remote control will be stored unless it is set again. However, it will be erased if the remote control is left with dead batteries. Set the same ID number again when the batteries are replaced.

### Note

- Set the ID number of the projector from the [PROJECTOR SETUP] menu → [PROJECTOR ID] (➔ page 69).

# Chapter 4 Settings

---

This chapter describes the settings and adjustments you can make using the on-screen menu.

# Menu Navigation

The on-screen menu (Menu) is used to perform various settings and adjustments of the projector.

## Navigating through the menu

### Operating procedure



- 1) Press the <MENU> button on the remote control or the control panel.
  - The main menu screen appears.



- 2) Press ▲▼ to select an item from the main menu.
  - The selected item is highlighted in yellow.



- 3) Press the <ENTER> button.
  - The sub-menu is displayed, and sub-menu items become selectable.

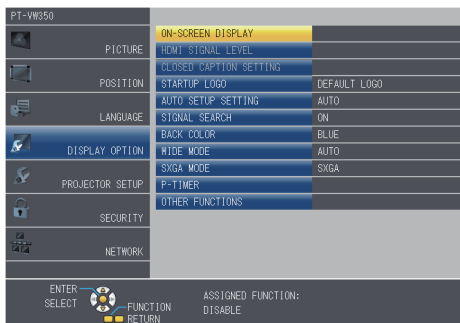

- 4) Press ▲▼ to select the desired sub-menu item, press ◀▶ or the <ENTER> button to set or adjust settings.

- Some items will switch in order as follows each time you press ◀▶.

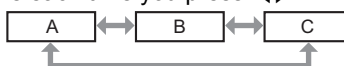

- For some items, press ◀▶ to display an individual adjustment screen with a bar scale as shown below.



**Note**

- Pressing the <MENU> button or <RETURN> button while the menu screen is displayed returns to the previous menu.
- Some items may not be adjusted or used for certain signal formats to be input to the projector. The menu items that cannot be adjusted or used are shown in gray characters, and they cannot be selected. [DIGITAL CINEMA REALITY] and [FRAME LOCK] may not be displayed depending on the input signal.
- Some items can be adjusted even if signals are not input.
- Individual adjustment screen is cleared automatically if no operation is performed for approximately five seconds.
- For menu items, refer to “Main menu” (➔ page 48) and “Sub-menu” (➔ page 49).

**Resetting adjustment values to the factory default**

If the <DEFAULT> button on the remote control is pressed, the values adjusted in the menu items are restored to the factory default settings.









1) Press the <DEFAULT> button on the remote control.

**Note**

- You cannot reset all the settings to the factory default at a time.
- To reset all the settings adjusted in the sub-menu item to the factory default one at a time, execute the [PROJECTOR SETUP] menu → [INITIALIZE ALL] (➔ page 75).
- Some items cannot be reset by pressing the <DEFAULT> button. Adjust each item manually.

**Main menu**

The main menu consists of the following 7 menu items.  
When a main menu item is selected, the screen changes to a sub-menu selection screen.

	Main-menu item	Page
	[PICTURE]	51
	[POSITION]	56
	[LANGUAGE]	61
	[DISPLAY OPTION]	62
	[PROJECTOR SETUP]	69
	[SECURITY]	76
	[NETWORK]	79



## Sub-menu

The sub-menu screen of the selected main menu appears, and you can set and adjust the various items in the sub-menu.

### [PICTURE]

Sub-menu item	Factory default	Page
[PICTURE MODE]	[STANDARD]	51
[CONTRAST]	[0]	51
[BRIGHTNESS]	[0]	52
[COLOR]*1	[0]	52
[TINT]*1	[0]	52
[SHARPNESS]	[8]	52
[COLOR TEMPERATURE]	[DEFAULT]	53
[IRIS]	[OFF]*2	53
[ADVANCED MENU]	-	53
[DAYLIGHT VIEW]	[AUTO]	53
[DIGITAL CINEMA REALITY]	[ON]	54
[NOISE REDUCTION]*3	[OFF]	54
[TV-SYSTEM]*3	[AUTO]	54
[RGB/Y <sub>P</sub> P <sub>R</sub> ]/[RGB/Y <sub>C</sub> C <sub>R</sub> ]*4	[AUTO]	55

\*1 Only for movie-based signals.

\*2 It may be different depending on the input signal.

\*3 Only when the <S-VIDEO IN >/<VIDEO IN> terminal is selected.

\*4 Only when the <COMPUTER 1 IN >/<HDMI IN> terminal is selected.

### Note

- The factory default settings may vary depending on the picture mode.

### [POSITION]

Sub-menu item	Factory default	Page
[REALTIME KEYSTONE]	[ON]	56
[KEYSTONE]	-	56
[SHIFT]	-	58
[DOT CLOCK]*1	[0]	58
[CLOCK PHASE]*1	[0]	58
[OVER SCAN]	-	59
[ASPECT]	-	59
[FRAME LOCK]*1	[OFF]	60

\*1 Only for still image signals.

### [LANGUAGE]

Details (➔ page 61)

### [DISPLAY OPTION]

Sub-menu item	Factory default	Page
[ON-SCREEN DISPLAY]	-	62
[HDMI SIGNAL LEVEL]	[AUTO]	63
[CLOSED CAPTION SETTING]	-	63
[SCREEN SETTING]*1	-	64
[STARTUP LOGO]	[DEFAULT LOGO]	64
[AUTO SETUP SETTING]	[AUTO]	65
[SIGNAL SEARCH]	[ON]	65
[BACK COLOR]	[BLUE]	65
[WIDE MODE]	-	65
[SXGA MODE]	-	65
[P-TIMER]	-	66
[P IN P]*1	-	67
[OTHER FUNCTIONS]	-	67

\*1 Only for PT-VW350.

**[PROJECTOR SETUP]** 

Sub-menu item	Factory default	Page
[STATUS]	-	69
[COMPUTER2 SELECT]	[COMPUTER2 IN]	69
[PROJECTOR ID]	[ALL]	69
[INITIAL START UP]	[LAST MEMORY]	70
[PROJECTION METHOD]	[FRONT/DESK]	70
[HIGH ALTITUDE MODE]	[OFF]	70
[LAMP POWER]	[NORMAL]	71
[ECO MANAGEMENT]	-	71
[EMULATE]	[DEFAULT]	72
[FUNCTION BUTTON]	-	73
[AUDIO SETTING]	-	73
[TEST PATTERN]	-	75
[FILTER COUNTER]	-	75
[INITIALIZE ALL]	-	75

**[SECURITY]** 

Sub-menu item	Factory Default	Page
[PASSWORD]	[OFF]	76
[PASSWORD CHANGE]	-	76
[TEXT DISPLAY]	[OFF]	77
[TEXT CHANGE]	-	77
[MENU LOCK]	[OFF]	77
[MENU LOCK PASSWORD]	-	77
[CONTROL DEVICE SETUP]	-	78

**[NETWORK]** 

Sub-menu item	Factory default	Page
[WIRED LAN]	-	79
[NAME CHANGE]	-	80
[NETWORK CONTROL]	[ON]	80
[AMX D.D.]	[OFF]	80
[Crestron Connected(TM)]	[OFF]	80
[STATUS]	-	81
[INITIALIZE]	-	81

**Note**

- Some items may not be adjusted or used for certain signal formats to be input to the projector.  
The menu items that cannot be adjusted or used are shown in gray characters, and they cannot be selected.
- Sub-menu items and factory default settings differ depending on the selected input terminal.

## [PICTURE] menu

On the menu screen, select [PICTURE] from the main menu, and select an item from the sub-menu. Refer to "Navigating through the menu" (→ page 47) for the operation of the menu screen. After selecting the item, press ▲▼◀▶ to set.

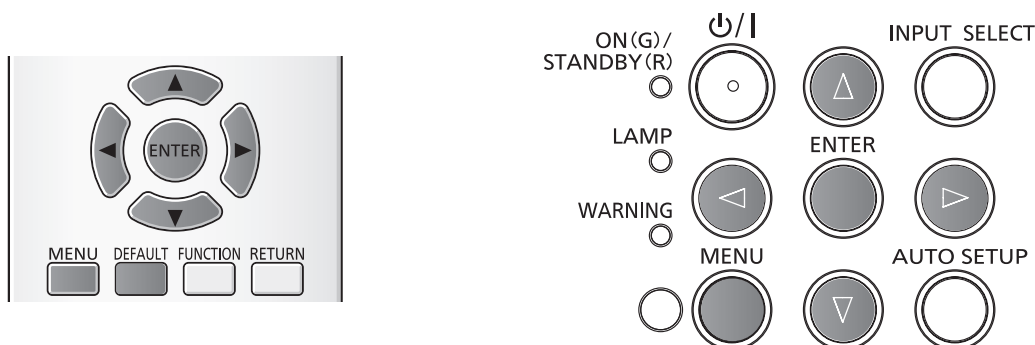

### [PICTURE MODE]

You can switch to the desired picture mode suitable for the image source and the environment in which the projector is used.

- 1) Press ▲▼ to select [PICTURE MODE].
- 2) Press ◀▶ or the <ENTER> button.
  - The [PICTURE MODE] individual adjustment screen is displayed.
- 3) Press ◀▶ to switch the item.
  - The items will switch each time you press the button.

[STANDARD]	The picture becomes suitable for moving images in general.
[DYNAMIC]	The light output is maximized for use in bright areas.
[BLACKBOARD]	The picture becomes suitable for projecting on a black board.
[WHITE BOARD]	The picture becomes suitable for projecting on a white board.
[CINEMA]*1	The picture becomes suitable for movie sources.
[NATURAL]*2	The picture becomes suitable for use in low-light areas.

\*1 Only for the movie-based signals.

\*2 Only for the still image signals.

### [CONTRAST]

You can adjust the contrast of the colors.

- 1) Press ▲▼ to select [CONTRAST].
- 2) Press ◀▶ or the <ENTER> button.
  - The [CONTRAST] individual adjustment screen is displayed.
- 3) Press ◀▶ to adjust the level.

Operation	Adjustment	Adjustment range
Press the ▶ button.	Brightens the screen and makes the color of image deeper.	-32 ~ +32
Press the ◀ button.	Darkens the screen and makes the color of image lighter.	

#### Attention

- Adjust [BRIGHTNESS] first when you need to adjust [BRIGHTNESS] and [CONTRAST].

**[BRIGHTNESS]**

You can adjust the dark (black) part of the projected image.

- 1) Press ▲▼ to select [BRIGHTNESS].
- 2) Press ◀▶ or the <ENTER> button.
  - The [BRIGHTNESS] individual adjustment screen is displayed.
- 3) Press ◀▶ to adjust the level.

Operation	Adjustment	Adjustment range
Press the ► button.	Increases the brightness of the dark (black) parts of the screen.	-32 ~ +32
Press the ◀ button.	Reduces the brightness of the dark (black) parts of the screen.	

**[COLOR]**

(Only for movie-based signal input)

You can adjust the color saturation of the projected image.

- 1) Press ▲▼ to select [COLOR].
- 2) Press ◀▶ or the <ENTER> button.
  - The [COLOR] individual adjustment screen is displayed.
- 3) Press ◀▶ to adjust the level.

Operation	Adjustment	Adjustment range
Press the ► button.	Deepens colors.	-32 ~ +32
Press the ◀ button.	Weakens colors.	

**[TINT]**

(Only for NTSC/NTSC4.43 signal, when inputting movie-based signal to the <S-VIDEO IN> terminal or the <VIDEO IN> terminal.)

You can adjust the skin tone in the projected image.

- 1) Press ▲▼ to select [TINT].
- 2) Press ◀▶ or the <ENTER> button.
  - The [TINT] individual adjustment screen is displayed.
- 3) Press ◀▶ to adjust the level.

Operation	Adjustment	Adjustment range
Press the ► button.	Adjusts skin tone toward greenish color.	-32 ~ +32
Press the ◀ button.	Adjusts skin tone toward reddish purple.	

**[SHARPNESS]**

You can adjust the sharpness of the projected image.

- 1) Press ▲▼ to select [SHARPNESS].
- 2) Press ◀▶ or the <ENTER> button.
  - The [SHARPNESS] individual adjustment screen is displayed.
- 3) Press ◀▶ to adjust the level.

Operation	Adjustment	Adjustment range
Press the ► button.	Contours become sharper.	0 ~ +15
Press the ◀ button.	Contours become softer.	

**Note**

- [SHARPNESS] will be invalid when [DAYLIGHT VIEW] is set to [AUTO] or [ON].

**[COLOR TEMPERATURE]**

You can switch the color temperature if the white areas of the projected image are bluish or reddish.

- 1) Press ▲▼ to select [COLOR TEMPERATURE].
- 2) Press ◀▶ or the <ENTER> button.
  - The [COLOR TEMPERATURE] individual adjustment screen is displayed.
- 3) Press ◀▶ to switch the item.
  - The items will switch each time you press the button.

[DEFAULT]	Factory default setting.
[HIGH]	Becomes a bluish image. Select this when the white areas of the projected image are reddish.
[LOW]	Becomes a reddish image. Select this when the white areas of the projected image are bluish.

**[IRIS]**

Aperture correction and signal compensation are performed automatically based on the image to result in an image of optimum contrast.

- 1) Press ▲▼ to select [IRIS].
- 2) Press ◀▶ or the <ENTER> button.
  - The [IRIS] individual adjustment screen is displayed.
- 3) Press ◀▶ to switch the item.
  - The items will switch each time you press the button.

[OFF]	No correction.
[ON]	Corrects the aperture.

**[ADVANCED MENU]**

You can perform more advanced image adjustment.

- 1) Press ▲▼ to select [ADVANCED MENU].
- 2) Press the <ENTER> button.
  - The [ADVANCED MENU] screen is displayed.
- 3) Press ▲▼ to select one item among [CONTRAST R] ~ [BRIGHTNESS B].
- 4) Press ◀▶ or the <ENTER> button.
  - The individual adjustment screen of items are displayed.
- 5) Press ◀▶ to adjust the value.

Items	Operation	Adjustment	Adjustment range
[CONTRAST R]	Press the ▶ button.	Emphasizes red in highlight areas.	-32 ~ +32
	Press the ◀ button.	Deemphasizes red in highlight areas.	
[CONTRAST G]	Press the ▶ button.	Emphasizes green in highlight areas.	-32 ~ +32
	Press the ◀ button.	Deemphasizes green in highlight areas.	
[CONTRAST B]	Press the ▶ button.	Emphasizes blue in highlight areas.	-32 ~ +32
	Press the ◀ button.	Deemphasizes blue in highlight areas.	
[BRIGHTNESS R]	Press the ▶ button.	Emphasizes red in shadow areas.	-32 ~ +32
	Press the ◀ button.	Deemphasizes red in shadow areas.	
[BRIGHTNESS G]	Press the ▶ button.	Emphasizes green in shadow areas.	-32 ~ +32
	Press the ◀ button.	Deemphasizes green in shadow areas.	
[BRIGHTNESS B]	Press the ▶ button.	Emphasizes blue in shadow areas.	-32 ~ +32
	Press the ◀ button.	Deemphasizes blue in shadow areas.	

**[DAYLIGHT VIEW]**

You can correct the image to the optimal vividness even if it is projected under a bright light.

- 1) Press ▲▼ to select [DAYLIGHT VIEW].
- 2) Press ◀▶ or the <ENTER> button.
  - The [DAYLIGHT VIEW] individual adjustment screen is displayed.

**3) Press ◀▶ to switch the item.**

- The items will switch each time you press the button.

[AUTO]	Enables auto correction of [DAYLIGHT VIEW]. The brightness of the room is detected by the luminance sensor, and the vividness of the image is automatically corrected.
[ON]	Enables [DAYLIGHT VIEW].
[OFF]	Disables [DAYLIGHT VIEW].

**Note**

- [DAYLIGHT VIEW] cannot be set to [AUTO] when the [PROJECTOR SETUP] menu → [PROJECTION METHOD] is set to [REAR/DESK] or [REAR/CEILING].
- The [AUTO] mode may not function properly if an object is placed on the top of the projector.

**[DIGITAL CINEMA REALITY]**

(Only for movie-based signal input)

You can improve the vertical resolution of 2-2 and 2-3 pull down video.

This function is available only with the following signal inputs.

525i (480i), 625i (576i), 1125 (1080)/60i, 1125 (1080)/50i, S-VIDEO signal, VIDEO signal.

**1) Press ▲▼ to select [DIGITAL CINEMA REALITY].****2) Press ◀▶ or the <ENTER> button.**

- The [DIGITAL CINEMA REALITY] individual adjustment screen is displayed.

**3) Press ◀▶ to switch the item.**

- The items will switch each time you press the button.

[OFF]	Disables [DIGITAL CINEMA REALITY].
[ON]	Enables [DIGITAL CINEMA REALITY].

**[NOISE REDUCTION]**

(Only when the <S-VIDEO IN >/<VIDEO IN> terminal is selected)

You can reduce noises when the input image is degraded and noise is occurring in the image signal.

**1) Press ▲▼ to select [NOISE REDUCTION].****2) Press ◀▶ or the <ENTER> button.**

- The [NOISE REDUCTION] individual adjustment screen is displayed.

**3) Press ◀▶ to switch the item.**

- The items will switch each time you press the button.

[OFF]	Disables [NOISE REDUCTION].
[ON]	Enables [NOISE REDUCTION].

**Attention**

- When this is set for an input signal with less noise, the image may look different from what it originally was. In such a case, set it to [OFF].

**[TV-SYSTEM]**

(Only when the <S-VIDEO IN >/<VIDEO IN> terminal is selected)

The projector will automatically detect the input signal, but you can set the color system manually when an unstable signal is input. Set the color system matching the input signal.

**1) Press ▲▼ to select [TV-SYSTEM].****2) Press ◀▶ or the <ENTER> button.**

- The [TV-SYSTEM] individual adjustment screen is displayed.

**3) Press ◀▶ to select the color system.**

- The items will switch each time you press the button.
- Select among [AUTO], [NTSC], [NTSC4.43], [PAL], [PAL-M], [PAL-N], [PAL60] and [SECAM].
- Set it to [AUTO] normally. (Setting [AUTO] will automatically select [NTSC], [NTSC4.43], [PAL], [PAL-M], [PAL-N], [SECAM] or [PAL60].)

**[RGB/YPbPr]/[RGB/YCbCr]**

Set it to [AUTO] normally. If images are not displayed correctly when this is set to [AUTO], set either [RGB], [YCbCr] or [YPbPr] in accordance with the input signal.

- 1) Press ▲▼ to select [RGB/YPbPr] or [RGB/YCbCr].
- 2) Press ◀▶ or the <ENTER> button.
  - The [RGB/YPbPr] or [RGB/YCbCr] individual adjustment screen is displayed.
- 3) Press ◀▶ to switch the item.
  - The items will switch each time you press the button.

[AUTO]	The sync signal automatically selects the signal [RGB]/ [YPbPr]/[YCbCr].
[RGB]	Select it for RGB signal input.
[YPbPr]	Select it for YPbPr signal input.
[YCbCr]	Select it for YCbCr signal input.

**When the <COMPUTER 1 IN> terminal is selected**

- **For 525i (480i), 625i (576i), 525p (480p) and 625p (576p) input**  
Select [AUTO], [RGB] or [YCbCr].
- **For other movie-based signal input**  
Select [AUTO], [RGB] or [YPbPr].

**When the <HDMI IN > terminal is selected**

- **For 525p (480p) and 625p (576p) input**  
Select [AUTO], [RGB] or [YCbCr].
- **For other movie-based signal input**  
Select [AUTO], [RGB] or [YPbPr].

**Note**

- Refer to "List of compatible signals" (➔ page 112) for the signal details.
- The signal selection may not function properly depending on connected devices.

## [POSITION] menu

On the menu screen, select [POSITION] from the main menu, and select an item from the sub-menu. Refer to "Navigating through the menu" (➔ page 47) for the operation of the menu screen.

• After selecting the item, press ▲▼◀▶ to set.

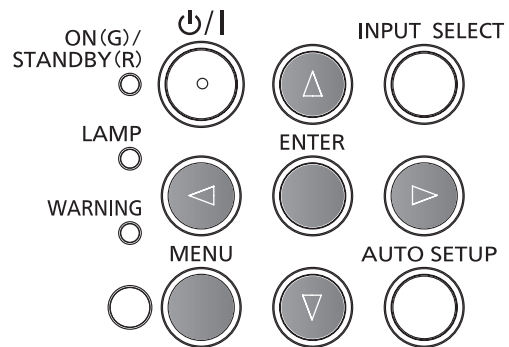
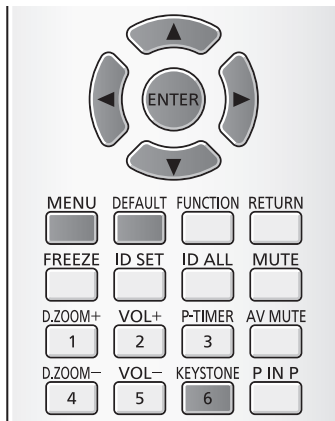

## [REALTIME KEYSTONE]

The projector can correct the vertical trapezoidal distortion automatically when the projector is installed tilted.

- 1) Press ▲▼ to select [REALTIME KEYSTONE].
- 2) Press ◀▶ or the <ENTER> button.
  - [REALTIME KEYSTONE] individual adjustment screen is displayed.
- 3) Press ◀▶ to switch the item.
  - The items will switch each time you press the button.

[OFF]	Set this function to off.
[ON]	Executes vertical keystone correction automatically when the projector is installed tilted.

### Note

- The [REALTIME KEYSTONE] function cannot work when the [FRONT/CEILING] or [REAR/CEILING] feature is selected in [PROJECTION METHOD] in the [PROJECTOR SETUP] menu.

## [KEYSTONE]

You can correct the trapezoidal distortion that occurs when the projector is installed tilted or when the screen is tilted.

- 1) Press ▲▼ to select [KEYSTONE].
- 2) Press the <ENTER> button.
  - The [KEYSTONE] screen is displayed.
- 3) Press ▲▼ to select one item to adjust.

[KEYSTONE]	Adjusts when the trapezoid of the projected image is distorted.
[CORNER CORRECTION]	Adjusts when the four corners of the projected image are distorted.

## [KEYSTONE]

- 1) Press ▲▼ to select [KEYSTONE].
- 2) Press the <ENTER> button.
  - The [KEYSTONE] screen is displayed.
- 3) Press ▲▼ to select [KEYSTONE].

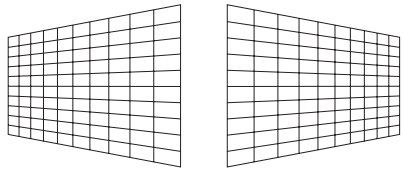
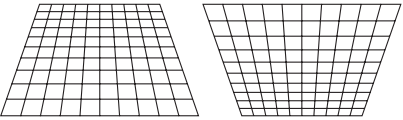

- 4) Press the <ENTER> button.
  - The [KEystone] individual adjustment screen is displayed.
- 5) Press ▲▼◀▶ to adjust the item.

Items	Operation		Adjustment	Adjustment range
[H]	Press the ▶ button.	Adjusts the right of the keystone.		-60 ~ +60
	Press the ◀ button.	Adjusts the left of the keystone.		
[V]	Press the ▲ button.	Adjusts the upper of the keystone.		-80 ~ +80
	Press the ▼ button.	Adjusts the bottom of the keystone.		

### [CORNER CORRECTION]

- 1) Press ▲▼ to select [KEYSTONE].
- 2) Press the <ENTER> button.
  - The [KEYSTONE] screen is displayed.
- 3) Press ▲▼ to select [CORNER CORRECTION].
- 4) Press the <ENTER> button.
  - The [CORNER CORRECTION] screen is displayed.
- 5) Press ▲▼ to select the item to adjust, then press the <ENTER> button.
  - The [CORNER CORRECTION] individual adjustment screen is displayed.
- 6) Press ▲▼◀▶ to adjust.

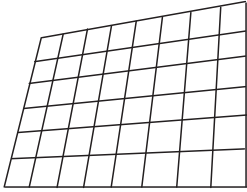
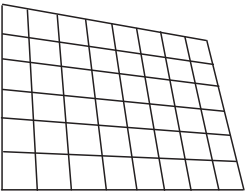
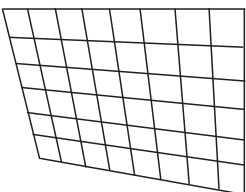
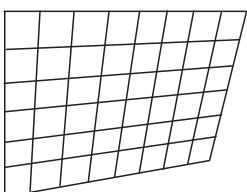
[CORNER CORRECTION]			
[UPPER LEFT]	[UPPER RIGHT]	[LOWER LEFT]	[LOWER RIGHT]
			

### Note

- Either [KEYSTONE] or [CORNER CORRECTION] setting value is valid. When [KEYSTONE] or [CORNER CORRECTION] adjustment is finished, you adjust the other one, the adjusted value will be reset.
- Press the <KEYSTONE> button on the remote control when the [KEYSTONE] or [CORNER CORRECTION] screen is displaying, it will switch to the other adjustment screen.
- When the [CORNER CORRECTION] individual adjustment screen is displaying, the individual adjustment screen of the next corner can also be displayed by pressing the <ENTER> button.
- Correcting up to  $\pm 40^\circ$  for the tilt in the vertical direction and  $\pm 30^\circ$  for the tilt in the horizontal are available for adjustments with [KEYSTONE]. However, the image quality will degrade and it will get harder to focus with more correction. Install the projector so that the correction will be as small as possible.
- Screen size will also change when [KEYSTONE] is used to perform various adjustments.
- Aspect ratio of the image size may shift depending on the correction.

## [SHIFT]

(Only for computer signal input)

Move the image position vertically or horizontally if the image position projected on the screen is shifted even when the relative position of the projector and the screen is installed correctly.

- 1) Press ▲▼ to select [SHIFT].
- 2) Press the <ENTER> button.
  - The [SHIFT] screen is displayed.
- 3) Press ▲▼◀▶ to adjust the position.

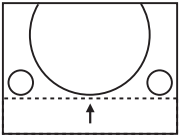
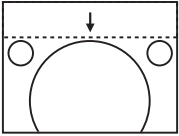
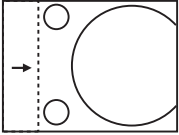
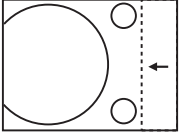
Orientation	Operation	Adjustment	
Vertical (up and down) adjustment.	Press the ▲ button.	The image position moves up.	
	Press the ▼ button.	The image position moves down.	
Horizontal (right and left) adjustment.	Press the ▶ button.	The image position moves to the right.	
	Press the ◀ button.	The image position moves to the left.	

### Note

- Depending on the input signal, if the adjustment of [SHIFT] exceeds the effective adjustment range of the input signal, the position of the image cannot be changed. Please adjust [SHIFT] within an effective adjustment range.

## [DOT CLOCK]

(Only for computer (RGB) signals input)

Use this function to adjust and minimize the effect of interference caused by projection of patterns consisting of vertical stripes. The projection of the striped pattern may cause cyclic patterns (noise). Adjust so that the amount of interference is at a minimum. You can adjust the dot clock of image.

- 1) Press ▲▼ to select [DOT CLOCK].
- 2) Press ◀▶ or the <ENTER> button.
  - The [DOT CLOCK] individual adjustment screen is displayed.
- 3) Press ◀▶ to adjust the value.
  - The adjustment values are [-32] to [+32].

### Attention

- Set it before adjusting [CLOCK PHASE].

## [CLOCK PHASE]

(Only for computer (RGB) signals input)

You can adjust to achieve an optimal image when there is a flickering image or smeared outlines.

- 1) Press ▲▼ to select [CLOCK PHASE].
- 2) Press ◀▶ or the <ENTER> button.
  - The [CLOCK PHASE] individual adjustment screen is displayed.

3) Press ◀▶ to adjust the value.

- The adjustment values are [-16] to [+16]. Adjust so that the amount of interference is at a minimum.

**Note**

- Certain signals may not be adjustable.
- Optimal value may not be achieved if the output from the input computer is unstable.
- To project a signal with dot clock frequency with 162 MHz or higher, noise may not disappear even if [CLOCK PHASE] is adjusted.
- [CLOCK PHASE] cannot be adjusted when a digital signal is input.

**[OVER SCAN]**

Use this function when characters or pictures are cropped near the periphery of the projected image.

1) Press ▲▼ to select [OVER SCAN].

2) Press ◀▶ or the <ENTER> button.

- The [OVER SCAN] individual adjustment screen is displayed.

3) Press ◀▶ to adjust the level.

- The adjustment values are [0] to [+3].

**Note**

- It is unavailable for still image computer (RGB) signals and still image HDMI signals.

**[ASPECT]**

You can switch the aspect ratio of the image.

The aspect ratio is switched within the screen range selected in [SCREEN SETTING]. Set [SCREEN SETTING] first.

(➔ page 64)

[SCREEN SETTING] is only for PT-VW350.

1) Press ▲▼ to select [ASPECT].

2) Press ◀▶ or the <ENTER> button.

- The [ASPECT] individual adjustment screen is displayed.

3) Press ◀▶ to switch the item.

- The items will switch each time you press the button.

[NORMAL]	Displays images without changing the aspect ratio of the input signals.
[AUTO]*1	The aspect ratio is automatically switched to the optimum aspect ratio when an aspect ratio identifier is included in the input signal.
[WIDE]	Displays images with the aspect ratio converted to 16:9 when standard signals*2 are input. Display images without changing the aspect ratio when wide-screen signals*3 are input.
[H FIT]	Displays images using the entire width of the screen. When signals have the aspect ratio vertically longer than the aspect ratio of the screen selected in [SCREEN FORMAT]*4, the images are displayed with the top and bottom parts cut off.
[V FIT]	Displays the height of the panel pixels vertically without changing the aspect ratio when wide-screen signals are input. When signals have the aspect ratio horizontally longer than the aspect ratio of the screen, the images are displayed with the right and left parts cut off.
[FULL]	The image is projected using all the panel (screen) pixels. The input signals are converted to the aspect ratio of the panel (screen).
[NATIVE]	Displays images without changing the resolution of the input signals.

\*1 Only for Video (NTSC) and 480i (YCbCr) signals input

\*2 Standard signals are input signals with an aspect ratio of 4:3 or 5:4.

\*3 Wide-screen signals are input signals with an aspect ratio of 16:10, 16:9 or 15:9.

\*4 [SCREEN FORMAT] is only for PT-VW350.

**Note**

- The image size may be switched abnormally when [AUTO] is selected, please set to [NORMAL] or [WIDE] according to the input signal.
- Some size modes are not available for certain types of input signals.
- If an aspect ratio which is different from the aspect ratio for the input signals is selected, the images will appear differently from the originals. Be careful of this when selecting the aspect ratio.
- If using the projector in places such as cafes or hotels to display programs for a commercial purpose or for public presentation, note that adjusting the aspect ratio or using the zoom function to change the screen images may be an infringement of the rights of the original copyright owner for that program under copyright protection laws. Take care when using a function of the projector such as the aspect ratio adjustment and zoom function.
- If conventional (normal) 4:3 images which are not wide-screen images are displayed on a wide screen, the edges of the images may not be visible or they may become distorted. Such images should be viewed as with an aspect ratio of 4:3 in the original format intended by the creator of the images.

**[FRAME LOCK]**

(Only for still image signals input)

This setting is available for specific computer signals. Set when the movie is distorted.

- 1) Press ▲▼ to select [FRAME LOCK].
- 2) Press ◀▶ or the <ENTER> button.
  - The [FRAME LOCK] individual adjustment screen is displayed.
- 3) Press ◀▶ to switch the [FRAME LOCK].
  - The items will switch each time you press the button.

[OFF]	Disables the frame lock.
[ON]	Enables the frame lock.

## [LANGUAGE] menu

On the menu screen, select [LANGUAGE] from the main menu, and select an item from the sub-menu. Refer to "Navigating through the menu" (➔ page 47) for the operation of the menu screen.

- Press ▲▼ to select a language, and press <ENTER> button to set.

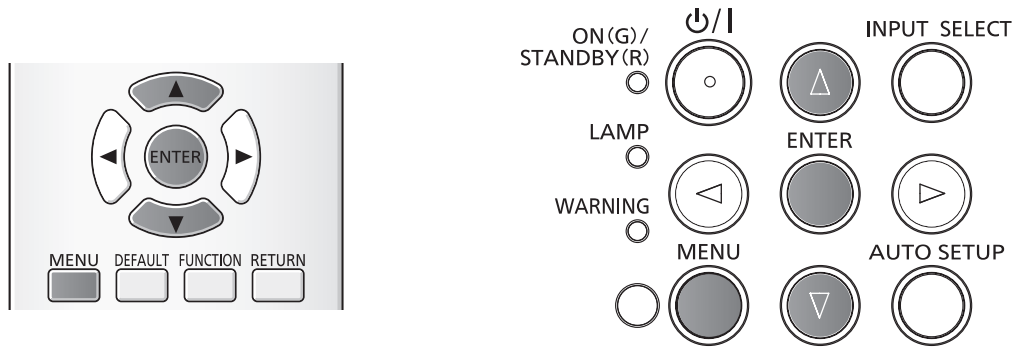

### [LANGUAGE]

You can select the language of the on-screen display.



- Various menus, settings, adjustment screens, control button names, etc., are displayed in the selected language.
- The language can be changed to English, German, French, Italian, Spanish, Portuguese, Dutch, Swedish, Finnish, Norwegian, Danish, Polish, Hungarian, Romanian, Czech, Russian, Turkish, Arabic, Kazakh, Vietnamese, Chinese, Korean, Japanese and Thai.

#### Note

- The on-screen display language of the projector is set to English by default and when [INITIALIZE ALL] (➔ page 75) in [PROJECTOR SETUP] is executed.

## [DISPLAY OPTION] menu

On the menu screen, select [DISPLAY OPTION] from the main menu, and select an item from the sub-menu. Refer to "Navigating through the menu" (➔ page 47) for the operation of the menu screen.

- After selecting the item, press ▲▼◀▶ to set.

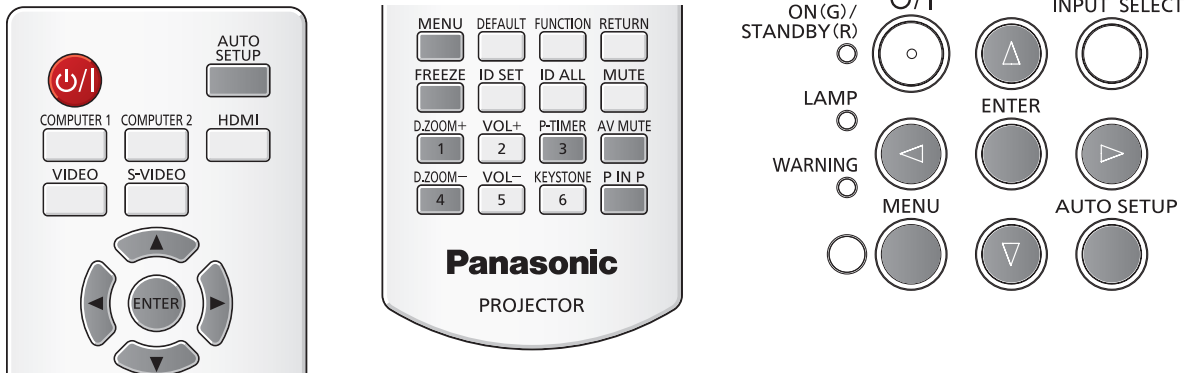

### [ON-SCREEN DISPLAY]

Set the on-screen display and position.

#### [INPUT GUIDE]

Set whether to display the input guide when switching the input source.

- 1) Press ▲▼ to select [ON-SCREEN DISPLAY].
- 2) Press the <ENTER> button.
  - The [ON-SCREEN DISPLAY] screen is displayed.
- 3) Press ▲▼ to select [INPUT GUIDE].
- 4) Press ◀▶ to switch the item.
  - The items will switch each time you press the button.

[DETAILED]	Displays the name of input terminal and input signal graphically.
[OFF]	Disables the input guide.
[SIMPLE]	Displays the name of input terminal and input signal.

### [OSD POSITION]

Set the position of the menu screen (OSD).

- 1) Press ▲▼ to select [ON-SCREEN DISPLAY].
- 2) Press the <ENTER> button.
  - The [ON-SCREEN DISPLAY] screen is displayed.
- 3) Press ▲▼ to select [OSD POSITION].
- 4) Press ◀▶ to switch the item.
  - The items will switch each time you press the button as following:  
[CENTER] → [UPPER LEFT] → [UPPER RIGHT] → [LOWER LEFT] → [LOWER RIGHT] → [CENTER] → ...

### [WARNING MESSAGE]

Set the display/hide of the warning message.

- 1) Press ▲▼ to select [ON-SCREEN DISPLAY].
- 2) Press the <ENTER> button.
  - The [ON-SCREEN DISPLAY] screen is displayed.

3) Press ▲▼ to select [WARNING MESSAGE].

4) Press ◀▶ to switch the item.

- The items will switch each time you press the button.

[OFF]	Hides the warning message.
[ON]	Displays the warning message.

## [HDMI SIGNAL LEVEL]

Switch the setting when the external equipment is connected to the <HDMI IN> terminal of the projector and the image is not projected correctly.

1) Press ▲▼ to select [HDMI SIGNAL LEVEL].

2) Press ◀▶ to switch the item.

- The items will switch each time you press the button.

[AUTO]	Sets the signal level automatically.
[64-940]	Select when the HDMI terminal of an external device (such as a blu-ray player) is connected to the <HDMI IN> terminal.
[0-1023]	Select when the DVI terminal output of an external device (such as a computer) is connected to the <HDMI IN> terminal via a conversion cable or similar cable. Select also when the HDMI terminal output of a computer or other device is connected to the <HDMI IN> terminal.

### Note

- The optimal setting varies depending on the output setting of the connected external device. Refer to the operation instruction of the external device regarding the output of the external device.
- The displayed signal level is assumed when the input is 30 bits.

## [CLOSED CAPTION SETTING]

(Only for NTSC, 480i YC<sub>B</sub>C<sub>R</sub> input)

Set the closed caption.

### Selecting the closed caption display

1) Press ▲▼ to select [CLOSED CAPTION SETTING].

2) Press the <ENTER> button.

- The [CLOSED CAPTION SETTING] screen is displayed.

3) Press ▲▼ to select [CLOSED CAPTION].

4) Press ◀▶ to switch the item.

- The items will switch each time you press the button.

[OFF]	Closed captions are not displayed.
[ON]	Closed captions are displayed.

- When [ON] is selected, proceed to Step 5).

5) When the confirmation is displayed, select [OK], and press the <ENTER> button.

### Setting the closed caption mode

1) Press ▲▼ to select [CLOSED CAPTION SETTING].

2) Press the <ENTER> button.

- The [CLOSED CAPTION SETTING] screen is displayed.

3) Press ▲▼ to select [MODE].

4) Press ◀▶ to switch the item.

- The items will switch each time you press the button.

[CC1]	Displays CC1 data.
-------	--------------------

[CC2]	Displays CC2 data.
[CC3]	Displays CC3 data.
[CC4]	Displays CC4 data.

**Note**

- Closed caption is a function that displays text information of video signals mainly used in North America. Captions may not be displayed depending on the connected devices or contents being played back.
- [CLOSED CAPTION SETTING] can only be selected if an NTSC or 480i YCbCr signal is input.
- If [CLOSED CAPTION SETTING] is set to [ON], the brightness of image may be changed according to the external devices or the used content of the closed caption corresponding connection.
- If a closed caption signal of the selected mode is input, the text is not displayed even when the [SECURITY] menu → [TEXT DISPLAY] (➔ page 77) is set to [ON].
- Closed captions are not displayed when the menu screen is displayed.

**[SCREEN SETTING]**

(Only for PT-VW350)

Set the screen size.

When changing the aspect of a projected image, correct to the optimum image position for the set screen. Set as necessary for the screen in use.

- 1) Press ▲▼ to select [SCREEN SETTING].
- 2) Press the <ENTER> button.
  - The [SCREEN SETTING] screen is displayed.
- 3) Press ▲▼ to select [SCREEN FORMAT].
- 4) Press ◀▶ to switch the [SCREEN FORMAT] item.
  - The items will switch each time you press the button.

[SCREEN FORMAT]	Description	Range when [SCREEN POSITION] is selected
[16:10]	The projected aspect ratio is 16:10.	Cannot be adjusted.
[16:9]	The projected aspect ratio is 16:9.	Adjusts the vertical position.

- 5) Press ▲▼ to select [SCREEN POSITION].
  - If [SCREEN FORMAT] is set to [16:10], adjustment of [SCREEN POSITION] is not available.
- 6) Press ◀▶ to adjust the [SCREEN POSITION].
  - The items will switch each time you press the button.

[HIGH]	The image which aspect ratio is 16:9 will displayed at the top.
[CENTER]	The image which aspect ratio is 16:9 will displayed in the center.
[LOW]	The image which aspect ratio is 16:9 will displayed at the bottom.

**[STARTUP LOGO]**

Set the logo display when the power is turned on.

- 1) Press ▲▼ to select [STARTUP LOGO].
- 2) Press ◀▶ to switch the item.
  - The items will switch each time you press the button.

[DEFAULT LOGO]	Displays the Panasonic logo.
[USER LOGO]	Displays the image registered by the user.
[OFF]	Disables the startup logo display.

**Note**

- The startup logo will disappear in approximately 30 seconds.
- To create/register the [USER LOGO] image, use "Logo Transfer Software" included in the supplied CD-ROM.
- If you do not register the image of the [USER LOGO], the startup logo will not be displayed even if the [STARTUP LOGO] is set to [USER LOGO].



## [AUTO SETUP SETTING]

Set the automatic execution of AUTO SETUP.

The screen display position or signal level can be adjusted automatically without pressing the <AUTO SETUP> button on the remote control or on the control panel on each occasion if you input unregistered signals frequently at meetings, etc.

- 1) Press ▲▼ to select [AUTO SETUP SETTING].
- 2) Press ◀▶ to switch the item.
  - The items will switch each time you press the button.

[AUTO]	Enables the auto setup function when switching signals.
[BUTTON]	Enables the auto setup function only when the <AUTO SETUP> button is pressed.

## [SIGNAL SEARCH]

When the power is turned on, this function automatically detects the terminal which signals are input and sets the function to switch.

- 1) Press ▲▼ to select [SIGNAL SEARCH].
- 2) Press ◀▶ to switch the item.
  - The items will switch each time you press the button.

[ON]	Enables input detection automatically.
[OFF]	Disables input detection automatically.

### Note

- If the [SIGNAL SEARCH] is set to [ON] when there is no signal input, press the <AUTO SETUP> button on the remote control or on the control panel, this function automatically detects the terminal to which signals are input and then switches.

## [BACK COLOR]

Set the display of the projected screen when there is no signal input.

- 1) Press ▲▼ to select [BACK COLOR].
- 2) Press ◀▶ to switch the item.
  - The items will switch each time you press the button.

[BLUE]	Displays the entire projection area in blue.
[BLACK]	Displays the entire projection area in black.
[DEFAULT LOGO]	Displays the Panasonic logo.
[USER LOGO]	Displays the image registered by the user.

### Note

- To create/register the [USER LOGO] image, use "Logo Transfer Software" included in the supplied CD-ROM.
- If you do not register the image of the [USER LOGO], the projected image will be displayed in black even if the [BACK COLOR] is set to [USER LOGO].

## [WIDE MODE]

Using this function when displays the incorrect signals input.

- 1) Press ▲▼ to select [WIDE MODE].
- 2) Press ◀▶ to switch the item.
  - The items will switch each time you press the button.

[AUTO]	Displays by judging the signal automatically. Set to this mode normally.
[ON]	When input the wide signal.
[OFF]	When input the 4:3 signal.

## [SXGA MODE]

This function is used if the whole projected image is not displayed when SXGA signal is input. Set it to [SXGA] normally.

- 1) Press ▲▼ to select [SXGA MODE].
- 2) Press ◀▶ to switch the item.
  - The items will switch each time you press the button.

[SXGA]	Normal setting.
[SXGA +]	Set this when the edge of the image is cropped.

## [P-TIMER]

Set and operate the presentation timer function.

1) Press ▲▼ to select [P-TIMER].

2) Press the <ENTER> button.

- The [P-TIMER] screen is displayed.

[MODE]	Switches the elapsed time between [COUNT UP] and [COUNT DOWN].
[TIMER]	Sets the finish time of timer when [COUNT DOWN] is selected.
[START] / [STOP] / [RESTART]	Operates the timer.
[RESET]	Resets the count.
[EXIT]	[P-TIMER] is finished.

### Setting [MODE]

1) Press ▲▼ to select [MODE].

2) Press ◀▶ to switch the item.

- The items will switch each time you press the button.

[COUNT UP]	Displays the elapsed time since the count was started.
[COUNT DOWN]	Displays the remaining time of the time set by [TIMER].

### Setting the countdown timer

1) Press ▲▼ to select [TIMER].

2) Press ◀▶ to set the timer.

- The time can be set in 1-minute increments from 1 to 180 minutes.
- The factory default value is 10 minutes.

#### Note

- [TIMER] is available only when [MODE] is set to [COUNT DOWN].

### The operation of [P-TIMER]

1) Press ▲▼ to select one item.

[START]	The count is started.
[STOP]	The count is stopped.
[RESTART]	The count is resumed.
[RESET]	The count is reset.

2) Press the <ENTER> button.

- When you select [START] or [RESTART], the remaining time or the elapsed time will be displayed in the lower right of the projected image.
- When you select [STOP], the remaining time or the elapsed time while stopping the counting will be displayed in the lower right of the projected image.

#### Note

- You can also use the P-TIMER function by pressing the <P-TIMER> button on the remote control (➡ page 43).
- If the elapsed time or remaining time is displaying, the text will not be displayed even when the [SECURITY] menu → [TEXT DISPLAY] (➡ page 77) is set to [ON].
- The elapsed time or remaining time will not be displayed when the menu screen is displaying.
- The start time will be "000:00" when [MODE] is set to [COUNT UP].
- When [MODE] is set to [COUNT DOWN], the start time becomes the value set at [TIMER].
- The time gauge turns clockwise when [COUNT UP] is set, and turns counterclockwise when [COUNT DOWN] is set.

### Ending the presentation timer

1) Press ▲▼ to select [P-TIMER].

2) Press the <ENTER> button.

- The [P-TIMER] screen is displayed.

- 3) Press ▲▼ to select [EXIT].
- 4) Press the <ENTER> button.

### [P IN P]

(Only for PT-VW350)

Locate a separate, small sub screen in the main screen to project two images simultaneously.

- 1) Press ▲▼ to select [P IN P].
- 2) Press the <ENTER> button.
  - The [P IN P] screen is displayed.

### [MODE]

- 1) Press ▲▼ to select [MODE].
- 2) Press ◀▶ to switch the item.
  - The items will switch each time you press the button.

[OFF]	P IN P function is disabled.
[SIDE BY SIDE]	Sub screen is displayed at the side of the main screen.
[P IN P]	Sub screen is displayed in the main screen.

### [SUBPICTURE SIZE]

If [MODE] is set to [P IN P], you can change the size of the sub screen.

- 1) Press ▲▼ to select [SUBPICTURE SIZE].
- 2) Press ◀▶ to switch the item.
  - The items will switch each time you press the button.

[SMALL]	The size of the sub screen is small (30% of the panel resolution).
[MIDDLE]	The size of the sub screen is middle (40% of the panel resolution).
[LARGE]	The size of the sub screen is large (50% of the panel resolution).

### [SUBPICTURE POSITION]

If [MODE] is set to [P IN P], you can change the position of the sub screen.

- 1) Press ▲▼ to select [SUBPICTURE POSITION].
- 2) Press ◀▶ to switch the item.
  - The items will switch each time you press the button as following:  
[LOWER RIGHT] → [LOWER LEFT] → [UPPER LEFT] → [UPPER RIGHT] → [LOWER RIGHT] → ...

#### Note

- The P IN P function may be unavailable for some signals being input or terminals being selected. Refer to "Two-window display combination list" (➔ page 111) for details.
- The main window setting values are applied to image adjustment values such as [PICTURE MODE] and [COLOR TEMPERATURE].

### [OTHER FUNCTIONS]

You can perform some of the remote control button operations from the sub-menu.

- 1) Press ▲▼ to select [OTHER FUNCTIONS].
- 2) Press the <ENTER> button.
  - The [OTHER FUNCTIONS] screen is displayed.
- 3) Press ▲▼ to select one item.

[AUTO SETUP]	For details, refer to "Using the AUTO SETUP function" (➔ page 41).
[FREEZE]	The projected image is paused temporarily and the sound stopped regardless of the playback of the external equipment. To release this function, press the <RETURN> button or the <FREEZE> button on the remote control.

[AV MUTE]	Turn off audio and image when the projector is not used for a certain period of time. To release this function, press the <RETURN> button or the <AV MUTE> button on the remote control.
[DIGITAL ZOOM]	For details, refer to "Using the DIGITAL ZOOM function" (➔ page 43).

4) Press the <ENTER> button.

## [PROJECTOR SETUP] menu

On the menu screen, select [PROJECTOR SETUP] from the main menu, and select an item from the sub-menu. Refer to "Navigating through the menu" (→ page 47) for the operation of the menu screen.

- After selecting the item, press ▲▼◀▶ to set.

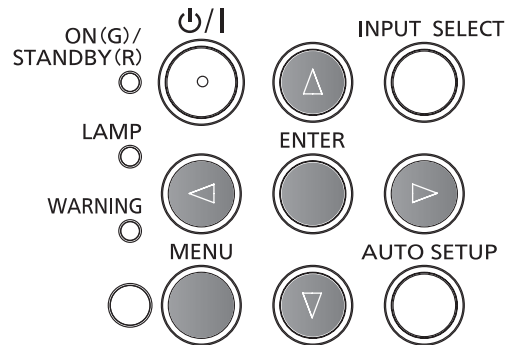
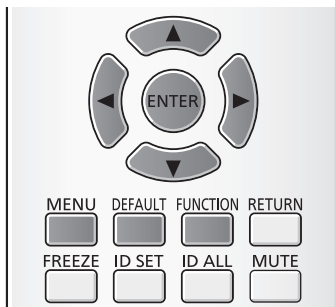

### [STATUS]

You can check the using status of the projector.

- 1) Press ▲▼ to select [STATUS].
- 2) Press the <ENTER> button.

- The [STATUS] screen is displayed.

[SIGNAL]	[NAME]	Displays the name of input signal.
	[FREQUENCY]	Displays the scanning frequency of input signal.
[RUNTIME]*1	[PROJECTOR]	Displays the current usage time of projector.
	[LAMP (ET-LAV300*2)]	Displays the model No. of the replacement lamp unit for this projector.
	[NORMAL]	Displays the lamp runtime when [LAMP POWER] is set to [NORMAL] by actual time.
	[ECO]	Displays the lamp runtime when [LAMP POWER] is set to [ECO] by actual time.
[SERIAL NUMBER]	[PROJECTOR]	Displays the serial number of the projector.

\*1 The following conversion is required to calculate the rough estimate for lamp replacement.

Formula for lamp replacement time (rough estimate)	
$A \times 1 + B \times 5/7$	
• A :	Runtime which is displayed in [STATUS] screen - [RUNTIME] - [LAMP] - [NORMAL]
• B :	Runtime which is displayed in [STATUS] screen - [RUNTIME] - [LAMP] - [ECO]

\*2 The model No. of the optional lamp unit is subject to change without prior notice.

### Note

- If you attach a lamp unit used in a projector of a model different from the projector (PT-VW350, PT-VX420) to the projector, or when the lamp unit used in the projector to a projector of a different model, the [RUNTIME] displayed in [STATUS] may differ from the actual time.

### [COMPUTER2 SELECT]

Set whether to use the <COMPUTER 2 IN/1 OUT> terminal.

- 1) Press ▲▼ to select [COMPUTER2 SELECT].
- 2) Press ◀▶ to switch the item.

- The items will switch each time you press the button.

[COMPUTER2 IN]	When input the computer signal.
[COMPUTER1 OUT]	Outputs the signal which have been input <COMPUTER 1 IN> terminal.

### Note

- The [COMPUTER2 SELECT] will be unavailable when [COMPUTER2] is selected as input source.

### [PROJECTOR ID]

The projector has an ID number setting function that can be used when multiple projectors are used side by side to enable simultaneous control or individual control via a single remote control.

- 1) Press ▲▼ to select [PROJECTOR ID].
- 2) Press the <ENTER> button.
  - The [PROJECTOR ID] screen is displayed.
- 3) Press ▲▼ to select a projector ID.
  - Select one from [ALL], and [1] to [6].

[ALL]	Select when controlling projectors without specifying an ID number.
[1] - [6]	Select when specifying an ID number to control individual projector.

- 4) Press the <ENTER> button to set it.
  - [PROJECTOR ID] is set.

**Note**

- To specify an ID number for individual control, the ID number of a remote control must match the ID number of the projector.
- When the ID number is set to [ALL], the projector will operate regardless of the ID number specified during remote control or computer control.  
If multiple projectors are set up side by side with ID set to [ALL], they cannot be controlled separately from the projectors with other ID numbers.
- Refer to “Setting the ID number of the remote control” (➔ page 45) for how to set the ID number on the remote control.

**[INITIAL START UP]**

Set the method of start up when the power cord plugged into the AC outlet.

- 1) Press ▲▼ to select [INITIAL START UP].
- 2) Press ◀▶ to switch the item.
  - The items will switch each time you press the button.

[LAST MEMORY]	Starts in the condition that before disconnected the power cord or turn off the breaker.
[STANDBY]	Starts up in the standby mode.
[ON]	Starts the projection immediately.

**[PROJECTION METHOD]**

Set the projection method in accordance with the installation status of the projector.  
Change the projection method if the screen display is upside down or inverted.

- 1) Press ▲▼ to select [PROJECTION METHOD].
- 2) Press ◀▶ to switch the projection method.
  - The items will switch each time you press the button.

[FRONT/DESK]	Select when installing the projector on the desk, etc., in front of the screen.
[FRONT/CEILING]	Select when installing the projector in front of the screen with the Ceiling Mount Bracket (optional).
[REAR/DESK]	Select when installing the projector on the desk, etc. behind the screen (with a translucent screen).
[REAR/CEILING]	Select when installing the projector behind the screen (with a translucent screen) with the Ceiling Mount Bracket (optional).

**[HIGH ALTITUDE MODE]**

Change the setting according to the altitude in which you use the projector.

- 1) Press ▲▼ to select [HIGH ALTITUDE MODE].
- 2) Press ◀▶ to switch the item.
  - The items will switch each time you press the button.

[OFF]	Select when using the projector in the elevation of below 1 400 m (4 593').
[HIGH1]	Select when using the projector in the elevation of above 1 400 m (4 593') and below 2 000 m (6 562').
[HIGH2]	Select when using the projector in the elevation of above 2 000 m (6 562') and below 2 700 m (8 858').

**Note**

- It is set to [OFF] when using the projector in the elevation of below 1 400 m (4 593'). It is set to [HIGH1] when using the projector in the elevation of above 1 400 m (4 593') and below 2 000 m (6 562'). It is set to [HIGH2] when using the projector in the elevation of above 2 000 m (6 562') and below 2 700 m (8 858'). Failure to do so may shorten the life of the internal parts and result in malfunctions.

- Do not set the projector in the elevation of 2 700 m (8 858') or above, otherwise it may shorten the life of the internal parts and result in malfunctions.
- When it is set to [HIGH1] or [HIGH2], the fan noise becomes louder and fan speed increases.

## [LAMP POWER]

Switch the brightness of the lamp according to the operating environment of the projector or the purpose.

1) Press ▲▼ to select [LAMP POWER].

2) Press ◀▶ to switch the item.

- The items will switch each time you press the button.

[NORMAL]	Select when high luminance is required.
[ECO]	Select when high luminance is not required.

### Note

- Set it to [ECO] rather than [NORMAL] when you want to reduce power consumption, extend the life of lamp and reduce operation noise.

## [ECO MANAGEMENT]

This function optimizes lamp power according to the operating status to reduce power consumption.

1) Press ▲▼ to select [ECO MANAGEMENT].

2) Press the <ENTER> button.

- The [ECO MANAGEMENT] screen is displayed.

3) Press ▲▼ to select one item.

### Setting [AUTO POWER SAVE] in step 3)

Set whether or not to enable the three functions, [AMBIENT LIGHT DETECTION], [SIGNAL DETECTION] and [AV MUTE DETECTION].

### Note

- [AUTO POWER SAVE] cannot be set when the [LAMP POWER] is set to [ECO].

4) Press ◀▶ to switch the [AUTO POWER SAVE].

[ON]	Enables power-saving mode.
[OFF]	Disables power-saving mode.

5) Press ▲▼ to select one item.

[AMBIENT LIGHT DETECTION]	Adjusts the lamp power according to the ambient brightness.
[SIGNAL DETECTION]	Drops the lamp power when no signal is input.
[AV MUTE DETECTION]	Drops the lamp power in the AV mute mode.

6) Press ◀▶ to switch the item.

- The items will switch each time you press the button.

[ON]	Enables above setting.
[OFF]	Disables above setting.

### Note

- Lamp power cannot be reduced automatically in the following cases:
  - When [LAMP POWER] is set to [ECO]
  - When the lamp lighting is just completed or the setting of [LAMP POWER] is just completed, etc..
- When [AUTO POWER SAVE] is set to [OFF], [AMBIENT LIGHT DETECTION], [SIGNAL DETECTION] and [AV MUTE DETECTION] cannot be set.
- [AMBIENT LIGHT DETECTION] will not work correctly when placing some objects on the ambient luminance sensor.

### Setting [POWER MANAGEMENT] in step 3)

Set the operation as following if there is no signal input.

1) Press ▲▼ to select [POWER MANAGEMENT].

2) Press ◀▶ to switch the item.

- The items will switch each time you press the button.

[SHUT DOWN]	The countdown timer is displayed after 30 seconds without input signal. The projection lamp is turned off and cooled down when reached the set time, then the projector enter into standby status.
[OFF]	Power management function is off.
[READY]	The countdown timer is displayed after 30 seconds without input signal. The projection lamp turns off and cools down when reaching the set time, meanwhile the projector is in the power management mode. The projection lamp will be turned on if the input signal is reconnected or any button is pressed.

### Setting [TIMER]

The timer can be set to 5-120 minutes. The increment is 5 minutes.

- 1) Press ▲▼ to select [TIMER].
- 2) Press ◀▶ to set the timer (5-120 MIN.).
  - The time will switch each time you press the button.

#### Note

- The factory default setting for [TIMER] is [15 MIN.].

### Setting [STANDBY MODE] in step 3)

Set the operation mode during standby. The default setting is [ECO] that keeps power consumption low during standby. When the network function or the serial communication function is used during standby, set to [NORMAL].

- 1) Press ▲▼ to select [STANDBY MODE].
- 2) Press ◀▶ to switch the item.
  - The items will switch each time you press the button.

[ECO]	Select this item to reduce power consumption during standby.
[NORMAL]	Select this item to use the network function or the serial communication function during standby.
[NETWORK]	Select this item to reduce power consumption during standby, and to operate the projector via the wired LAN or the serial communication function by using the Wake on LAN function.

#### Note

- If [STANDBY MODE] is set to [ECO], you cannot use network functions when the projector is standing by. Also, you cannot use some RS-232C protocol commands.
- When set to [ECO], it may take approx. 10 seconds longer before the projector starts projecting after the power is turned on, compared with when [NORMAL] is set.
- If [STANDBY MODE] is set to [NETWORK], it takes less power consumption than it is set to [NORMAL].
- When [STANDBY MODE] is set to [NETWORK], it will be no restriction for network function and serial communication function within 60 seconds when the Wake on LAN function is working.
- The setting of [STANDBY MODE] cannot be returned to the factory default even if the [PROJECTOR SETUP] menu → [INITIALIZE ALL] is executed (► page 75).

### [EMULATE]

When controlling the projector on a computer via the <SERIAL IN> terminal, set use of control commands on a previously purchased Panasonic projector. This allows the control software for an existing Panasonic projector to be inherited and used.

- 1) Press ▲▼ to select [EMULATE].
- 2) Press the <ENTER> button.
  - The [EMULATE] screen is displayed.
- 3) Press ▲▼ to select one item.

[DEFAULT]	VW350 series, VX420 series, VZ575N series, VW535N series, VX605N series, EZ580 series, EW640 series, EX610 series, EW540 series, EZ770 series, EW730 series, EX800 series, VW345N series, VX415N series, VW340Z, VX410Z, VX42Z, RZ475 series, RZ470 series, RW430 series, RZ370 series, RW330 series
[D3500]	D3500 series
[D4000]	D4000 series
[D/W5k SERIES]	D5700 series, DW5100 series, D5600 series, DW5000 series, D5500 series
[D/W/Z6k SERIES]	DZ770 series, DW740 series, DX810 series, DZ680 series, DW640 series, DX610 series, DW730 series, DX800 series, DZ6710 series, DZ6700 series, DW6300 series, D6000 series, D5000 series, DZ570 series, DW530 series, DX500 series
[L730 SERIES]	L730 series, L720 series, L520 series
[L780 SERIES]	L780 series, L750 series
[L735 SERIES]	L735 series
[L785 SERIES]	L785 series
[F/W SERIES]	FW430 series, FX400 series, FW300 series, F300 series, F200 series, FW100 series, F100 series
[LZ370]	LZ370 series
[LB/W SERIES]	LB3 series, LB2 series, LB1 series, ST10 series, LB90 series, LW80NT series, LB80 series, LB78 series, LB75 series



[VX500 SERIES]	VW435N series, VW440 series, VW430 series, VX505N series, VX510 series, VX500 series, VW330 series, VX400NT series, VX400 series, VX41 series
[EZ570 SERIES]	EZ570 series, EW630 series, EW530 series, EX600 series, EX500 series
[VW431D]	VW431D series

4) Press the <ENTER> button.

## [FUNCTION BUTTON]

The function assigned to the <FUNCTION> button of the remote control is displayed. You can also release the assigned setting.

### Releasing assigned function to the <FUNCTION> button

- 1) Press ▲▼ to select [FUNCTION BUTTON].
- 2) Press the <ENTER> button.
  - The [FUNCTION BUTTON] screen is displayed.
- 3) Press the <ENTER> button.
- 4) When the confirmation message is displayed, select [OK] and press the <ENTER> button.

#### Note

- You can also cancel the assigned settings by displaying the on-screen menu, selecting the menu item to be canceled (main menu, sub-menu or details menu), and then pressing the <FUNCTION> button for at least 3 seconds.

## [AUDIO SETTING]

You can perform more detailed setting for Audio.

### Adjusting the volume

- 1) Press ▲▼ to select [AUDIO SETTING].
- 2) Press the <ENTER> button.
  - The [AUDIO SETTING] screen is displayed.
- 3) Press ▲▼ to select [VOLUME].
- 4) Press ◀▶ to adjust the level.

Operation	Adjustment	Range
Press the ▶ button.	Turns up the volume.	0 ~ 63
Press the ◀ button.	Turns down the volume.	

### Setting the mute

- 1) Press ▲▼ to select [AUDIO SETTING].
- 2) Press the <ENTER> button.
  - The [AUDIO SETTING] screen is displayed.
- 3) Press ▲▼ to select [MUTE].
- 4) Press ◀▶ to switch the item.

[OFF]	Output the audio.
[ON]	Turns off the volume temporarily.

### Setting the audio output during standby

- 1) Press ▲▼ to select [AUDIO SETTING].
- 2) Press the <ENTER> button.
  - The [AUDIO SETTING] screen is displayed.
- 3) Press ▲▼ to select [IN STANDBY MODE].
- 4) Press ◀▶ to switch [IN STANDBY MODE].
  - The items will switch each time you press the button.

[OFF]	Disables audio output in the standby mode.
[ON]	Enables audio output in the standby mode when [STANDBY MODE] is set to [NORMAL]. At this time, press the <VOL - > button / <VOL +> button on the remote control or ◀▶ buttons on the control panel to adjust the volume.

**Note**

- When [ECO MANAGEMENT] → [STANDBY MODE] is set to [ECO] (➔ page 72), even if [IN STANDBY MODE] is set to [ON], audio cannot be output during standby.

**Setting audio input selection**

Choose the audio input terminal for each input signal.

- 1) Press ▲▼ to select [AUDIO SETTING].
- 2) Press the <ENTER> button.
  - The [AUDIO SETTING] screen is displayed.
- 3) Press ▲▼ to select one item of [AUDIO IN SELECT].

[COMPUTER1]	Set the audio output when [COMPUTER1] input is selected.
[COMPUTER2]	Set the audio output when [COMPUTER2] input is selected.
[VIDEO]	Set the audio output when [VIDEO] input is selected.
[S-VIDEO]	Set the audio output when [S-VIDEO] input is selected.
[HDMI]	Set the audio output when [HDMI] input is selected.

- 4) Press ◀▶ to switch the item.
  - The sub items will switch each time you press the button.

[COMPUTER1]	Select one item among [AUDIO IN 1], [AUDIO IN 2] or [AUDIO IN 3].
[COMPUTER2]	Select one item among [AUDIO IN 1], [AUDIO IN 2] or [AUDIO IN 3].
[VIDEO]	Select one item among [AUDIO IN 1], [AUDIO IN 2] or [AUDIO IN 3].
[S-VIDEO]	Select one item among [AUDIO IN 1], [AUDIO IN 2] or [AUDIO IN 3].
[HDMI]	Select one item among [HDMI AUDIO IN], [AUDIO IN 1], [AUDIO IN 2] or [AUDIO IN 3].

**Note**

- When [MIC] is set to [ON], [AUDIO IN 2] cannot be selected.
- Even if [AUDIO IN 2] is selected, it will change to [AUDIO IN 1] automatically when [MIC] is set to [ON].

**Using MIC function**

- 1) Press ▲▼ to select [AUDIO SETTING].
- 2) Press the <ENTER> button.
  - The [AUDIO SETTING] screen is displayed.
- 3) Press ▲▼ to select [MIC].
- 4) Press ◀▶ to switch the item.
  - The items will switch each time you press the button.

[OFF]	MIC is disabled.
[ON]	<AUDIO IN 2> terminal switches to MIC input.

- 5) Press ▲▼ to select [MIC GAIN].
- 6) Press ◀▶ to adjust the level.

Operation	Adjustment	Range
Press the ▶ button.	Turns up the MIC mixing gain.	0 ~ 63
Press the ◀ button.	Turns down the MIC mixing gain.	

**Note**

- When [OFF] is selected in MIC function, the MIC GAIN function is not available.
- If the MIC function is set to [ON] when connecting audio signals to the <AUDIO IN 2 (MIC IN)> terminal, loud sound may be output suddenly depending on the setting value of [MIC GAIN].
- When [MIC] is set to [ON], no signal is input, AV MUTE function is on, FREEZE function is on or the POWER MANAGEMENT function is working, the audio of MIC will be output.

## [TEST PATTERN]

Displays the test pattern built-in to the projector.

Settings of position, size, and other factors will not be reflected in test patterns. Make sure to display the input signal before performing various adjustments.

1) Press ▲▼ to select [TEST PATTERN].

2) Press the <ENTER> button.

- The test pattern with the [PATTERN CHANGE] individual adjustment screen is displayed.

3) Press ◀▶ to switch the item.

- The items will switch each time you press the button.  
All white → Color bars → White cross on the black background → Black cross on the white background → Cross hatch → All white →...
- When you press the <MENU> button or <RETURN> button, it will exit the test pattern and return to the sub-menu of [PROJECT SETUP].

### Note

- The initial setting is All white. The initial screen is Cross hatch if you have assigned it to the <FUNCTION> button.

## [FILTER COUNTER]

This function is used to reset the filter use time and set the notification display.

1) Press ▲▼ to select [FILTER COUNTER].

2) Press the <ENTER> button.

- The [FILTER COUNTER] screen is displayed.

[FILTER COUNTER]	Displays the using time of the filter.
[TIMER]	Sets the timer when you want to display an alert message of filter replacement.
[FILTER COUNTER RESET]	Resets the filter counter.

### Setting [TIMER]

1) Press ▲▼ to select [TIMER].

2) Press ◀▶ to switch the setting of the timer.

- The items will switch each time you press the button.  
[OFF] → [1000 H] → [2000 H] → [3000 H] → [4000 H] → [5000 H] → [6000 H] → [7000 H]

## [FILTER COUNTER RESET]

1) Press ▲▼ to select [FILTER COUNTER RESET].

2) Press the <ENTER> button.

- The [FILTER COUNTER RESET] screen is displayed.

3) Press ◀▶ to select [OK] and then press the <ENTER> button.

## [INITIALIZE ALL]

Return various setting values to their factory default settings.

1) Press ▲▼ to select [INITIALIZE ALL].

2) Press the <ENTER> button.

- The [INITIALIZE ALL] screen is displayed.

3) When the confirmation is displayed, press ◀▶ to select [OK] and then press the <ENTER> button.

- The [NOW INITIALIZING...] screen is displayed and then the [POWER OFF.] screen will be displayed.

4) Press the <ENTER> button.

- The operation of other buttons is disabled.
- The initial setting (display language) screen will be displayed when turning on the projector next time.

### Note

- The projector will enter into the standby status to reflect the setting values when [INITIALIZE ALL] is executed.
- When [INITIALIZE ALL] is executed, [STANDBY MODE], [EMULATE], [FILTER COUNTER] and the setting values of [NETWORK] cannot be returned to the factory default values. For details about the initialization of [NETWORK], please refer to [NETWORK] → [INITIALIZE] (➡ page 81).

## [SECURITY] menu

On the menu screen, select [SECURITY] from the main menu, and select an item from the sub-menu. Refer to "Navigating through the menu" (→ page 47) for the operation of the menu screen.

- When the projector is used for the first time Initial password: Press ▲▶▼◀▲▶▼◀ in order, and press the <ENTER> button.
- After selecting the item, press ▲▼◀▶ to set.

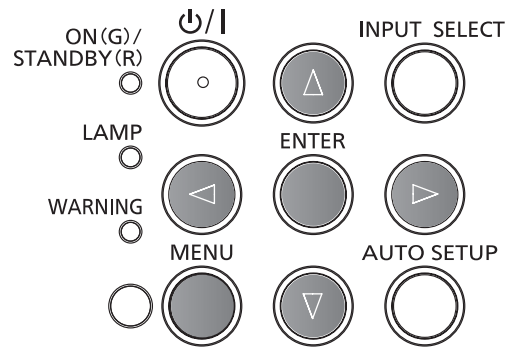
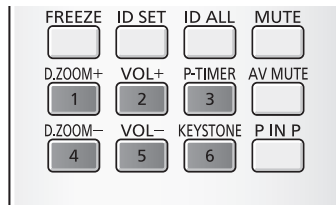
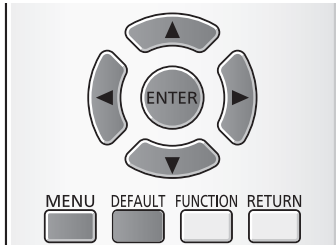

### Attention

- When you select the [SECURITY] menu and press the <ENTER> button, entering a password is required. Enter the preset password and then continue operations of the [SECURITY] menu.
- When the password has been changed previously, enter the changed password, and press the <ENTER> button.

### Note

- The entered password is displayed with "\*" mark on the screen.
- An error message is displayed on the screen when the entered password is incorrect. Re-enter the correct password.

## [PASSWORD]

The [PASSWORD] screen is displayed when the power is turned on, [INITIALIZE ALL] is executed or [INITIALIZE] in the [NETWORK] menu is executed. When the entered password is incorrect, the operation will be restricted to the power standby <⏻/|> button on the control panel or on the remote control.

1) Press ▲▼ to select [PASSWORD].

2) Press ◀▶ to switch the item.

- The items will switch each time you press the button.

[OFF]	Disables the security password entry.
[ON]	Enables the security password entry.

### Note

- The [PASSWORD] setting is set to [OFF] by the factory default.
- Change the password periodically that is hard to guess.
- The security password is enabled after setting [PASSWORD] to [ON], turning the power off and disconnecting the power plug from the power outlet.

## [PASSWORD CHANGE]

Change the security password.

1) Press ▲▼ to select [PASSWORD CHANGE].

2) Press the <ENTER> button.

- The [PASSWORD CHANGE] screen is displayed.

3) Press ▲▼◀▶ or number buttons (<1>-<6>) to set the password.

- Up to eight button operations can be set.

4) Press the <ENTER> button.

5) Re-enter the password for the confirmation.

6) Press the <ENTER> button.

**Note**

- The entered password is displayed with "\*" mark on the screen.
- An error message is displayed on the screen when the entered password is incorrect. Re-enter the correct password.
- If numbers have been used for the security password, the security password will need to be initialized again if the remote control is lost. Consult your dealer for the initialization method.

**[TEXT DISPLAY]**

Overlap the security message (text) over the projecting image.

- 1) Press ▲▼ to select [TEXT DISPLAY].
- 2) Press ◀▶ to switch the item.
  - The items will switch each time you press the button.

[OFF]	Disables the text display.
[ON]	Enables the text display.

**[TEXT CHANGE]**

Change the text displayed when the text display is enabled by selecting [ON] in [TEXT DISPLAY].

- 1) Press ▲▼ to select [TEXT CHANGE].
- 2) Press the <ENTER> button.
  - The [TEXT CHANGE] screen is displayed.
- 3) Press ▲▼◀▶ to select the text, and press the <ENTER> button to enter the text.
- 4) Press ▲▼◀▶ to select [OK], and press the <ENTER> button.
  - The text is changed.

**[MENU LOCK]**

Display the menu by the <MENU> button and set whether or not to enable menu operations.

- 1) Press ▲▼ to select [MENU LOCK].
- 2) Press ◀▶ to switch the item.
  - The items will switch each time you press the button.

[OFF]	Unlocks menu operations.
[ON]	Locks menu operations.

**Note**

- When the entered password is incorrect after setting [MENU LOCK] to [ON], the <MENU> button cannot be operated.
- [MENU LOCK] is set to [OFF] at the time of purchase or when [INITIALIZE ALL] is executed.
- When [MENU LOCK] is set to [ON] and then enter the password to release the lock, the unlock state is held until the projector enters the standby mode.

**[MENU LOCK PASSWORD]**

Change the menu lock password.

- 1) Press ▲▼ to select [MENU LOCK PASSWORD].
- 2) Press the <ENTER> button.
  - The [MENU LOCK PASSWORD] screen is displayed.
- 3) Press ▲▼◀▶ to select the text, and press the <ENTER> button to enter the text.
  - Up to 16 characters can be input.
- 4) Press ▲▼◀▶ to select [OK], and press the <ENTER> button.
  - To cancel, select [CANCEL].

**Attention**

- The initial password is "AAAA" at the time of purchase or when [INITIALIZE ALL] is executed.
- Change the password periodically that is hard to guess.

**[CONTROL DEVICE SETUP]**

Enable/disable the button operations on the control panel and the remote control.

1) Press ▲▼ to select [CONTROL DEVICE SETUP].

2) Press the <ENTER> button.

- The [CONTROL DEVICE SETUP] screen is displayed.

3) Press ▲▼ to select one item between [CONTROL PANEL] and [REMOTE CONTROLLER].

[CONTROL PANEL]	You can set the limitation on the control from the control panel.
[REMOTE CONTROLLER]	You can set the limitation on the control from the remote control.

4) Press ◀▶ to switch between [ENABLE] and [DISABLE].

- You can set the limitation on the control from the control panel or the remote control.

[ENABLE]	Enable the button operations.
[DISABLE]	Disable the button operations.

- A confirmation screen will be displayed when you change [ENABLE] to [DISABLE], then proceed to Step 5).

5) Press ◀▶ to select [OK], and then press the <ENTER> button.

**Note**

- When a button operation is performed on the device set to [DISABLE], the [PASSWORD] screen is displayed. To continue operations, enter the security password.
- The [PASSWORD] screen will disappear when there is no operation for approx. 10 seconds.
- If the operations of both [CONTROL PANEL] and [REMOTE CONTROLLER] are set to [DISABLE], the projector cannot be turned off (cannot enter standby).
- Even when you set button operations on the remote control to be disabled, operations of the <ID ALL> and <ID SET> buttons on the remote control are enabled.

## [NETWORK] menu

On the menu screen, select [NETWORK] from the main menu, and select an item from the sub-menu. Refer to "Navigating through the menu" (⇒ page 47) for the operation of the menu screen.

- After selecting the item, press ▲▼◀▶ to set.

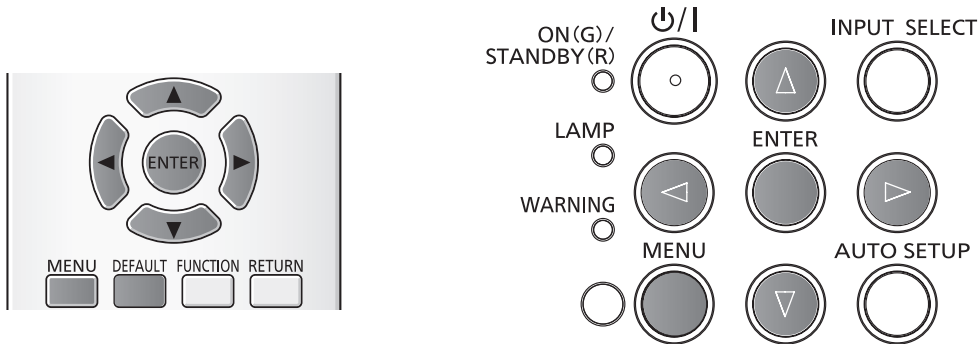

### [WIRED LAN]

You can make detailed wired LAN settings.

- 1) Press ▲▼ to select [WIRED LAN].
- 2) Press the <ENTER> button.
  - The [WIRED DETAILED SETUP] screen is displayed.
- 3) Press ▲▼ to select an item, and change the setting according to the instructions.

[DHCP]	<p><b>[ON]:</b> If a DHCP server exists in the network to which the projector is connected, the IP address will automatically be acquired.</p> <p><b>[OFF]:</b> If a DHCP server does not exist in the network to which the projector is connected, additionally set [IP ADDRESS], [SUBNET MASK] and [DEFAULT GATEWAY].</p>
[IP ADDRESS]	Enter the IP address if DHCP server is not used.
[SUBNET MASK]	Enter the subnet mask if DHCP server is not used.
[DEFAULT GATEWAY]	Enter the gateway address if DHCP server is not used.
[DNS1]	Enter the DNS server address if DHCP server is not used.
[DNS2]	Enter the alternate DNS server address if DHCP server is not used.

- 4) Press ▲▼ to select [OK], and press the <ENTER> button.

#### ■ Default wired LAN settings

- The following settings are set before the projector leaves the factory.

[DHCP]	OFF
[IP ADDRESS]	192.168.10.100
[SUBNET MASK]	255.255.255.0
[DEFAULT GATEWAY]	192.168.10.1
[DNS1] / [DNS2]	NONE

#### Note

- When using a DHCP server, confirm that the DHCP server is running.
- Consult your network administrator regarding the IP ADDRESS, SUBNET MASK, and DEFAULT GATEWAY.

**[NAME CHANGE]**

You can change the projector name, for example, when using the DHCP server.

- 1) Press ▲▼ to select [NAME CHANGE].
- 2) Press the <ENTER> button.
  - The [NAME CHANGE] screen is displayed.
- 3) Select characters with the ▲▼◀▶ buttons and press the <ENTER> button to enter the projector name.
  - Select [ALL DELETE] to delete all the entered characters, or press the <DEFAULT> button on the remote control to delete a character on the cursor in the entry field.
- 4) Select [OK] with the ▲▼ buttons and press the <ENTER> button.
  - To cancel the change of the name, select [CANCEL] and press the <ENTER> button.

**Note**

- [Name □□□□] (□□□□ is 4-digit number) is set before the projector leaves the factory.

**[NETWORK CONTROL]**

Set when you want to control the projector from a computer connected to the network.

- 1) Press ▲▼ to select [NETWORK CONTROL].
- 2) Press ◀▶ to switch the item.
  - The items will switch each time you press the button.

[ON]	This function is enabled. Web control, PJLink control, the command control of the LAN are enabled.
[OFF]	This function is disabled.

**[AMX D.D.]**

Set to [ON] to control with the controller of AMX Corporation.

Setting this function to [ON] enables detection through "AMX Device Discovery". For details, refer to the website of AMX Corporation.

URL <http://www.amx.com/>

- 1) Press ▲▼ to select [AMX D.D.].
- 2) Press ◀▶ to switch the item.
  - The items will switch each time you press the button.

[OFF]	This function is disabled.
[ON]	This function is enabled.

**[Crestron Connected(TM)]**

Set to [ON] to control with Crestron Connected™ of Crestron Electronics, Inc.

- 1) Press ▲▼ to select [Crestron Connected(TM)].
- 2) Press ◀▶ to switch the item.
  - The items will switch each time you press the button.

[OFF]	This function is disabled.
[ON]	This function is enabled.



**[STATUS]**

Displays the current network status.

1) Press ▲▼ to select [STATUS].

2) Press the <ENTER> button.

- The [STATUS] screen is displayed.

[DHCP]	Displays the usage state of the DHCP server.
[IP ADDRESS]	Displays the IP address.
[SUBNET MASK]	Displays the subnet mask.
[DEFAULT GATEWAY]	Displays the default gateway.
[DNS1]	Displays the address of the primary DNS server.
[DNS2]	Displays the address of the secondary DNS server.
[MAC ADDRESS]	Displays the MAC address.

**[INITIALIZE]**

This function is used to return various setting values of [NETWORK] to the factory default value.

1) Press ▲▼ to select [INITIALIZE].

2) Press the <ENTER> button.

- The [INITIALIZE] screen is displayed.

3) Press ◀▶ to select [OK] and then press the <ENTER> button.

**Network connections**

The projector has a network function, and the following operations are available from the computer using the web browser control.

- Setting and adjustment of the projector.
- Display of the projector status.
- Transmission of an E-mail message when there is a problem with the projector.

The projector supports "Crestron Connected™", and the following application software of Crestron Electronics, Inc. can be used.

- RoomView Express
- Fusion RV
- RoomView Server Edition

**Note**

- "Crestron Connected™" is a system developed by Crestron Electronics, Inc. which collectively manage and control multiple system devices connected via the network, from a computer. This projector supports "Crestron Connected™".
- For details of "Crestron Connected™", refer to the Crestron Electronics, Inc. website. (Provided only in English.)  
<http://www.crestron.com/>  
For the download of "RoomView Express", refer to the Crestron Electronics, Inc. website. (Provided only in English.)  
<http://www.crestron.com/getroomview>

**Computer that can be used**

In order to use the Web control function, a Web browser is required. Confirm that the Web browser can be used beforehand.

OS	Compatible web browser
Windows	Internet Explorer 8.0 / 9.0 / 10.0 / 11.0
Mac OS	Safari 6.0 / 7.0 / 8.0

**Note**

- Communication with an E-mail server is required to use the E-mail function. Confirm that the E-mail can be used beforehand.

## Connecting with Wired LAN

### Example of a normal network connection

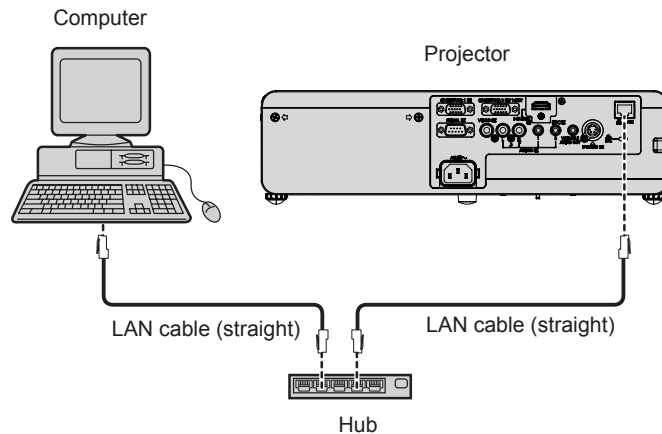

#### Attention

- When a LAN cable is directly connected to the projector, the network connection must be made indoors.

#### Note

- A LAN cable is required to use the network function.
- Use shielded LAN cable (STP cable) that is compatible with category 5 or above.
- Use a LAN cable with length of 100 m or shorter.

#### Projector settings

- 1) Use the LAN cable to connect the projector with computer.
- 2) Turn on the projector.
- 3) Press the <MENU> button to display the [NETWORK] menu, and then select [WIRED LAN], and press the <ENTER> button.
- 4) Set the detailed setup of [WIRED LAN].
  - For details, refer to "WIRED LAN". (➔ page 79)

#### Note

- Please confirm with your network administrator before you connect to an existing network.
- The following settings are set before the projector leaves the factory.

[DHCP]	OFF
[IP ADDRESS]	192.168.10.100
[SUBNET MASK]	255.255.255.0
[DEFAULT GATEWAY]	192.168.10.1
[DNS1] / [DNS2]	NONE

#### Computer setting

- 1) Turn on the computer.
- 2) Make the network setting according to your system administrator.
  - If the projector settings are the default settings, the computer can be used with the following network settings.

[IP ADDRESS]	192.168.10.101
[SUBNET MASK]	255.255.255.0
[DEFAULT GATEWAY]	192.168.10.1

## Accessing from the web browser

- 1) Start up the web browser on the computer.
- 2) Enter the IP address set on the projector into the URL entry field of the web browser.
- 3) Enter the user name and the password.
  - The factory default setting of the user name is user1 (user rights)/admin1 (administrator rights) and the password is panasonic (lower case).

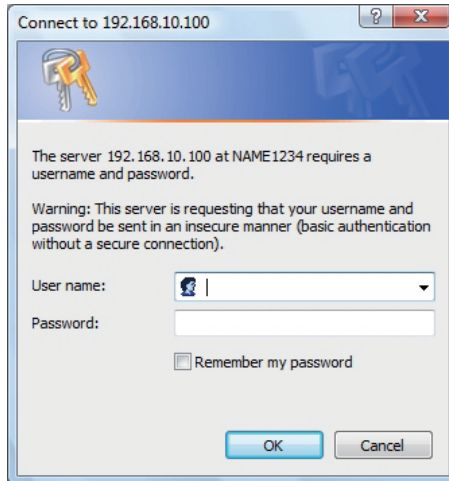

- 4) Click [OK].
  - The [Projector status] page is displayed.

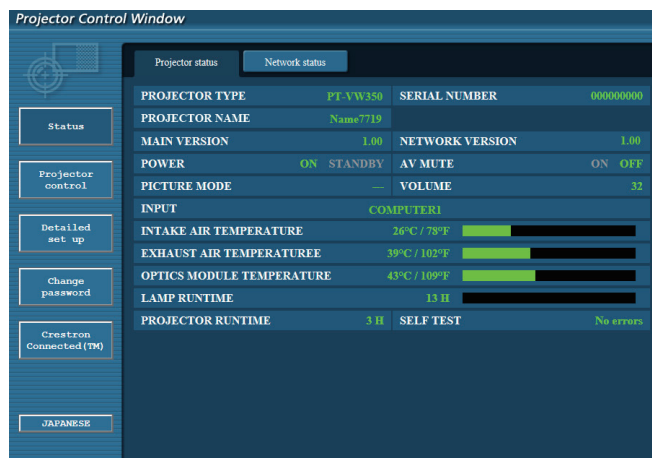

### Note

- If you use a web browser to control the projector, set [NETWORK CONTROL] to [ON] in [NETWORK] (➔ page 80).
- Do not perform setting or control simultaneously by starting up multiple web browsers. Do not set or control the projector from multiple computers.
- Change the password first. (➔ page 93)
- Access will be locked for few minutes when an incorrect password is entered three times consecutively.
- Some items on the projector setting page use the Javascript function of the web browser. The projector may not be able to be controlled properly if it is set with a browser that does not have this function enabled.
- If the screen for the web control is not displayed, consult your network administrator.
- While updating the screen for the web control, the screen may become white for a moment, but it is not a malfunction.

### Available functions per account

With the administrator rights, all functions can be used. With the user rights, available functions are restricted. Select an account according to the purpose of use.

Item	Function	Administrator rights*1	User rights*1	Page
[Status]	[Projector status]	✓	✓	85
	Error information page	✓	✓	86
	[Network status]	✓	✓	86
[Projector control]	[Basic control]	✓	✓	87
	[Advanced control]	✓	✓	87
[Detailed set up]	[Network config]	✓	—	88
	[Ping test]	✓	—	89
	[E-mail set up]	✓	—	89
	[Authentication set up]	✓	—	90
	[ECO management set up]	✓	—	93
[Change password]	User name for [Administrator]	✓	—	94
	User name for [User]	✓	—	94
	Password for [Administrator]	✓	—	94
	Password for [User]	✓	✓	94
[Crestron Connected(TM)]	Operation	✓	—	95
	[Tools]	✓	—	95
	[Info]	✓	—	96
	[Help]	✓	—	96

\*1 The functions with ✓ marks in the columns of administrator rights/user rights indicate that the operation can be performed by each right.

### Description of each item

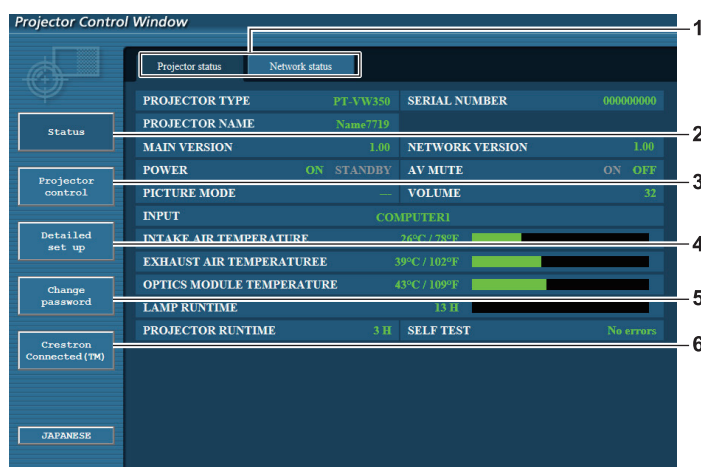

- 1 **Page tab**  
Switches pages by clicking this item.
- 2 **[Status]**  
The status of the projector is displayed by clicking this item.
- 3 **[Projector control]**  
The [Projector control] page is displayed by clicking this item.
- 4 **[Detailed set up]**  
The [Detailed set up] page is displayed by clicking this item.
- 5 **[Change password]**  
The [Change password] page is displayed by clicking this item.
- 6 **[Crestron Connected(TM)]**  
The control page of Crestron Connected™ is displayed by clicking this item.

[Projector status] page

Click [Status] → [Projector status].

Display the status of the projector for the following items.

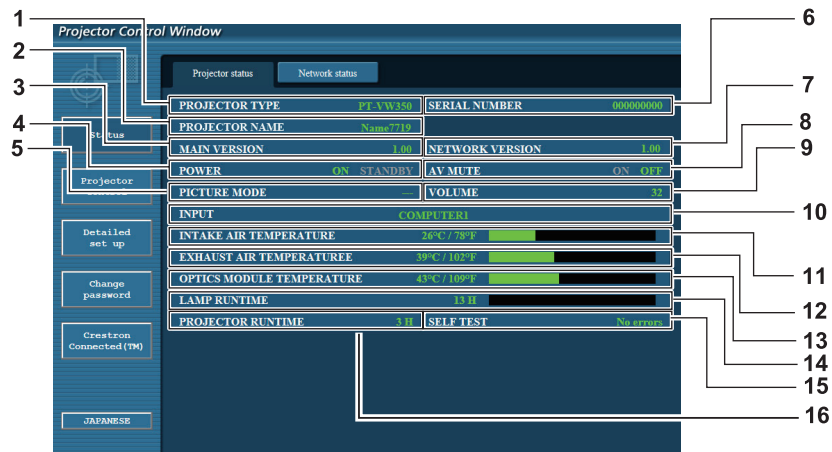

- |  |   |
|--|---|
| <p>1 <b>[PROJECTOR TYPE]</b><br/>Displays the type of projector.</p> <p>2 <b>[PROJECTOR NAME]</b><br/>Displays the name set in the projector.</p> <p>3 <b>[MAIN VERSION]</b><br/>Displays the firmware version of the projector.</p> <p>4 <b>[POWER]</b><br/>Displays the status of the power.</p> <p>5 <b>[PICTURE MODE]</b><br/>Displays the status of the picture mode.</p> <p>6 <b>[SERIAL NUMBER]</b><br/>Displays the serial number of the projector.</p> <p>7 <b>[NETWORK VERSION]</b><br/>Displays the version of firmware of the network.</p> <p>8 <b>[AV MUTE]</b><br/>Displays the AV mute status.</p> <p>9 <b>[VOLUME]</b><br/>Displays the volume status.</p> | <p>10 <b>[INPUT]</b><br/>Displays the status of the selected input.</p> <p>11 <b>[INTAKE AIR TEMPERATURE]</b><br/>Displays the status of the air intake temperature of the projector.</p> <p>12 <b>[EXHAUST AIR TEMPERATURE]</b><br/>Displays the status of the exhaust air temperature of the projector.</p> <p>13 <b>[OPTIC MODULE TEMPERATURE]</b><br/>Displays the optics module temperature status of the projector.</p> <p>14 <b>[LAMP RUNTIME]</b><br/>Displays the runtime of the lamp (converted value).</p> <p>15 <b>[SELF TEST]</b><br/>Displays the self diagnostics information.</p> <p>16 <b>[PROJECTOR RUNTIME]</b><br/>Displays the runtime of the projector.</p> |
|--|---|

**Error information page**

When [Error (Detail)] or [Warning (Detail)] is displayed in the self-diagnosis display of the [Projector status] screen, click it to display the error/warning details.

- The projector may go into the standby status to protect the projector depending on the contents of the error.

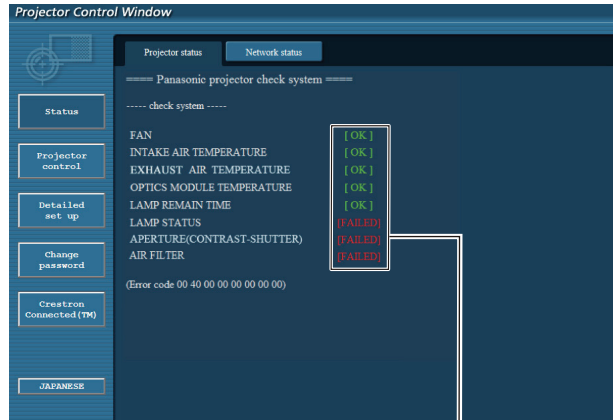
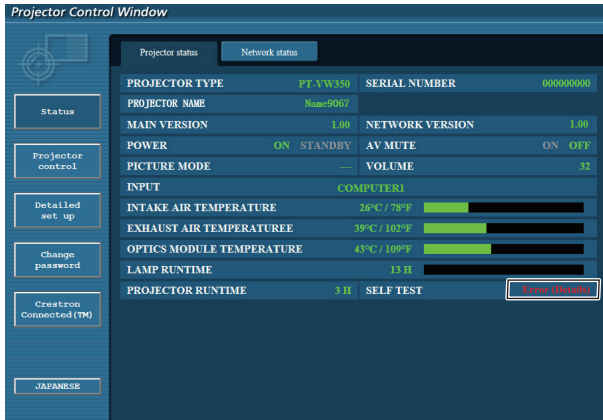

**1 Self-diagnosis result display**

Displays the item check results.

[OK]: Indicates that operation is normal.

[FAILED]: Indicates that there is a problem.

[WARNING]: Indicates that there is a warning.

■ [FAILED] items displayed when a problem occurs

Parameter	Description
[FAN]	Trouble has occurred in the fan or its drive circuit. Consult your dealer.
[FAN(INTAKE)]	Trouble has occurred in the intake fan.
[FAN(EXHAUST)]	Trouble has occurred in the exhaust fan.
[FAN(LAMP)]	Trouble has occurred in the lamp cooling fan.
[INTAKE AIR TEMPERATURE]	The air intake temperature is too high. The projector may be used in an operating environment where the temperature is high, such as near a heating appliance.
[EXHAUST AIR TEMPERATURE]	The exhaust air temperature is high. The air exhaust port may be blocked.
[OPTICS MODULE TEMPERATURE]	The temperature around the optics module inside the projector is high. The projector may be used in an operating environment where the temperature is high, such as near a heating appliance.
[LAMP REMAIN TIME]	The lamp runtime has exceeded the prescribed cumulative time, and it is now time to replace the lamp.
[LAMP STATUS]	The lamp has failed to light. Wait a short while for the lamp to cool off, and then turn on the power.
[APERTURE (CONTRAST-SHUTTER)]	Trouble has occurred in the contrast shutter circuitry. Consult your dealer.
[AIR FILTER]	There is too much dust accumulated in the air filter unit. Turn off the projector and unplug the power plug from the wall outlet, then replace the air filter unit.

**[Network status] page**

Click [Status] → [Network status].

The current network setting status is displayed.

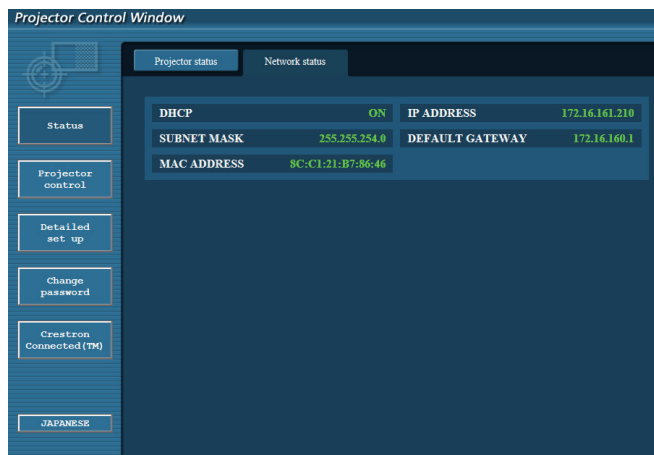

**[Basic control] page**

Click [Projector control] → [Basic control].

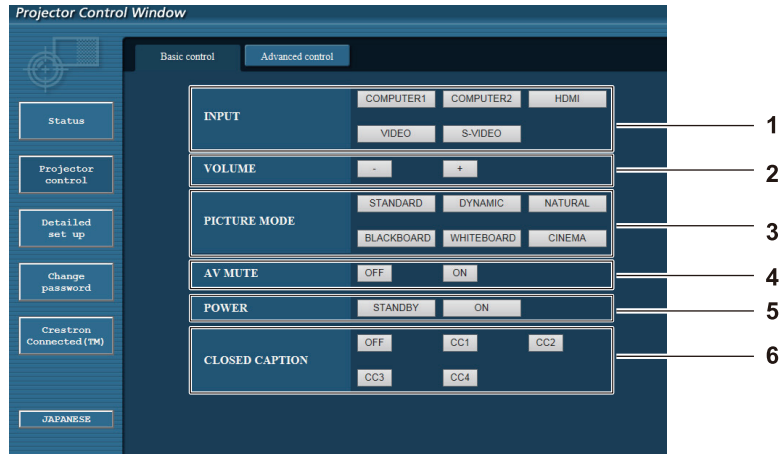

- |   |   |
|---|---|
| <p><b>1 [INPUT]</b><br/>Switches the input signal.</p> <p><b>2 [VOLUME]</b><br/>Adjusts the volume level.</p> <p><b>3 [PICTURE MODE]</b><br/>Switches the picture mode.</p> | <p><b>4 [AV MUTE]</b><br/>Switches between AV mute on/off.</p> <p><b>5 [POWER]</b><br/>Turns on/off the power.</p> <p><b>6 [CLOSED CAPTION]</b><br/>Switches the closed caption mode.</p> |
|---|---|

**[Advanced control] page**

Click [Projector control] → [Advanced control].

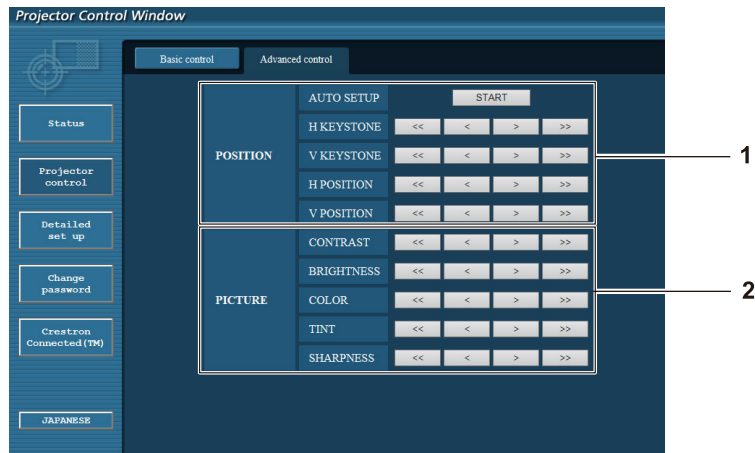

- |   |   |
|---|---|
| <p><b>1 [POSITION]</b><br/>Adjusts the position of image and the keystone correction.</p> | <p><b>2 [PICTURE]</b><br/>Adjusts the items of image.</p> |
|---|---|

[Network config] page

Click [Detailed set up] → [Network config].

- 1) Click [Network config].
  - The [CAUTION!] screen is displayed.

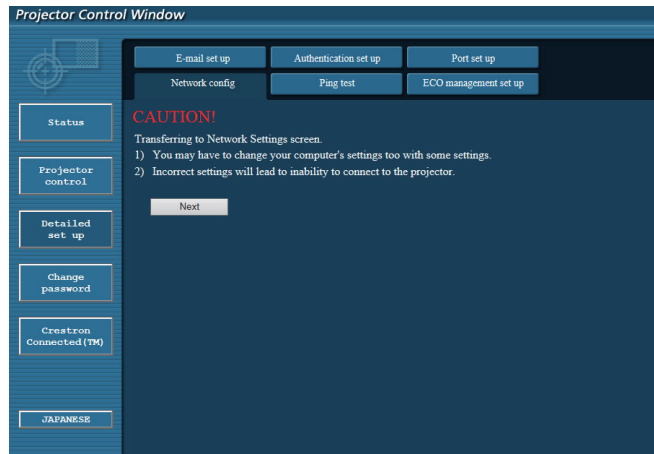

- 2) Select the item which you want to change the setting, then click [Next].
  - The current setting is displayed.
- 3) Click [Change] button.
  - The setting change screen is displayed.

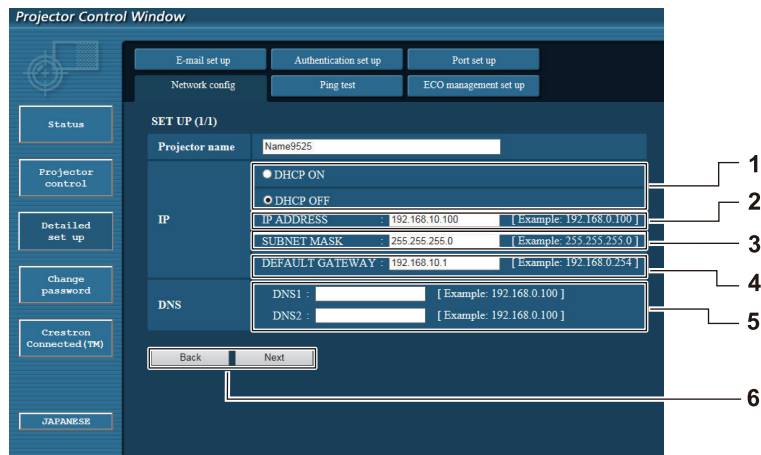

- |   |   |
|---|---|
| <ol style="list-style-type: none"> <li>1 [DHCP ON]/[DHCP OFF]<br/>To enable the DHCP client function, set to [DHCP ON].</li> <li>2 [IP ADDRESS]<br/>Enter the IP address when not using a DHCP server.</li> <li>3 [SUBNET MASK]<br/>Enter the subnet mask when not using a DHCP server.</li> <li>4 [DEFAULT GATEWAY]<br/>Enter the default gateway address when not using a DHCP server.</li> </ol> | <ol style="list-style-type: none"> <li>5 [DNS1]/[DNS2]<br/>Enter the DNS1/DNS2 server address.<br/>Permissible/ available characters for the entry of DNS1/ DNS2 server address.<br/>(primary):<br/>Numbers (0 - 9), period (.)<br/>(Example: 192.168.0.253).</li> <li>6 [Back]/[Next]<br/>Click the [Back] button to return to the original screen.<br/>The current settings are displayed by pressing the [Next] button.<br/>Click the [Submit] button to update the settings.</li> </ol> |
|---|---|

Note

- When you use the “Forward” and “Back” functions of your browser, a warning message “Page has Expired” may appear. In that case, click [Network config] again since the following operation will not be guaranteed.
- Changing LAN settings while connected to the LAN may cause the connection to cut out.



**[Ping test] page**

Check whether the network is connected to the mail server, POP server, DNS server, etc.  
Click [Detailed set up] → [Ping test].

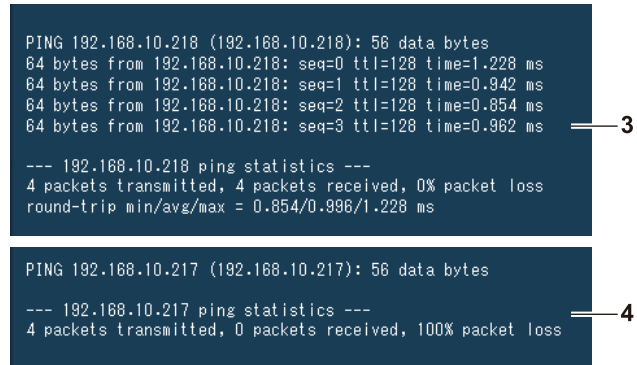
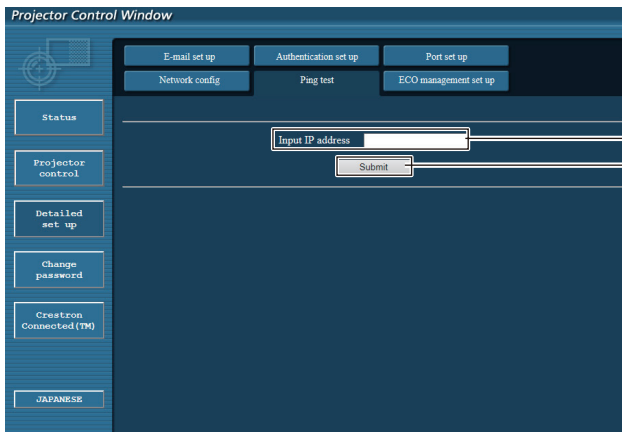

- 1 **[Input IP address]**  
Enter the IP address of the server to be tested.
- 2 **[Submit]**  
Executes the connection test.
- 3 **Example of display when the connection has succeeded**
- 4 **Example of display when the connection has failed**

**[E-mail set up] page**

When there is a problem or the runtime of a lamp reaches a set value, an E-mail can be sent to preset E-mail addresses (up to two addresses).

Click [Detailed set up] → [E-mail set up].

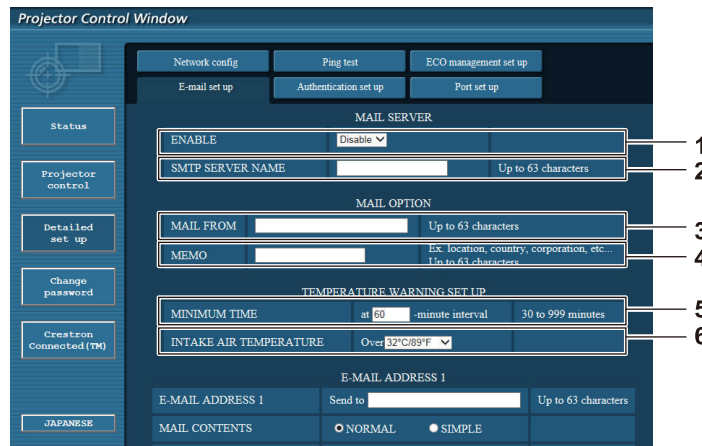

- 1 **[ENABLE]**  
Select [Enable] to use the E-mail function.
- 2 **[SMTP SERVER NAME]**  
Enter the IP address or the server name of the E-mail server (SMTP). To enter the server name, the DNS server needs to be set up.
- 3 **[MAIL FROM]**  
Enter the E-mail address of the projector. (Up to 63 characters in single byte)
- 4 **[MEMO]**  
Enter information such as the location of the projector that notifies the sender of the E-mail. (Up to 63 characters in single byte)
- 5 **[MINIMUM TIME]**  
Change the minimum interval for the temperature warning E-mail. The default value is 60 minutes. In this case, another E-mail will not be sent for 60 minutes after sending the temperature warning E-mail even if it reaches the warning temperature.
- 6 **[INTAKE AIR TEMPERATURE]**  
Change the temperature setting for the temperature warning mail. A temperature warning E-mail is sent when the temperature exceeds this value.

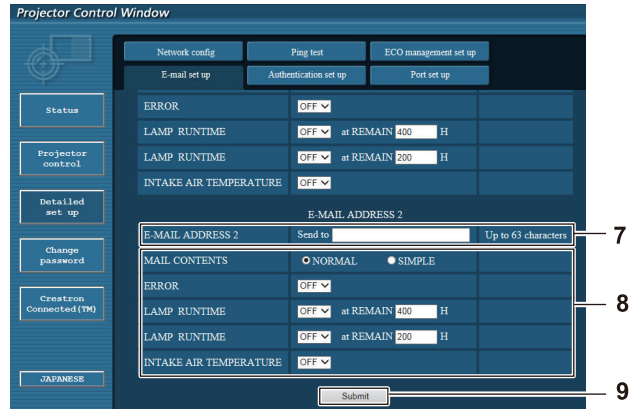
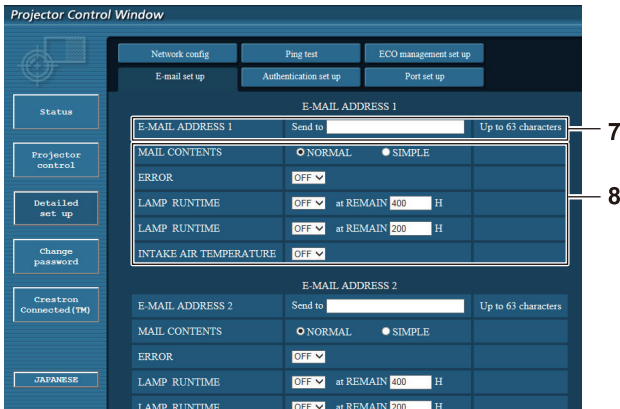

- 7 **[E-MAIL ADDRESS 1]/[E-MAIL ADDRESS 2]**  
Enter the E-mail address to be sent. Leave [E-MAIL ADDRESS 2] blank when two E-mail addresses are not to be used.
- 8 **Settings of the conditions to send E-mail**  
Select the conditions to send E-mail.  
**[MAIL CONTENTS]:**  
Select either [NORMAL] or [SIMPLE].  
**[ERROR]:**  
Send an E-mail when an error occurred in the self-diagnosis.

- [LAMP RUNTIME]:**  
An E-mail message is sent when the remaining lamp on time for the lamp has reached the value set at the right field.
- [INTAKE AIR TEMPERATURE]:**  
Send an E-mail when the air intake temperature has reached the value set at the above field.
- 9 **[Submit]**  
Update the settings.

**[Authentication set up] page**

Set the authentication items when POP authentication or SMTP authentication is necessary to send an E-mail. Click [Detailed set up] → [Authentication set up].

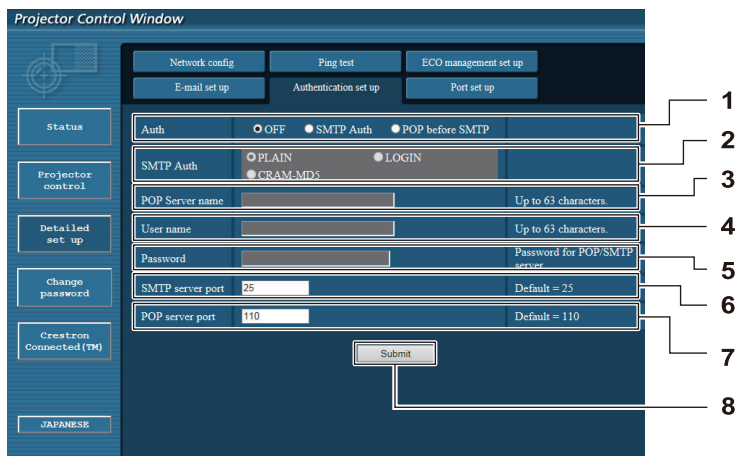

- 1 **[Auth]**  
Select the authentication method specified by your Internet service provider.
- 2 **[SMTP Auth]**  
Set when the SMTP authentication is selected.
- 3 **[POP server name]**  
Enter the POP server name.  
Allowed characters:  
Alphanumerics (A - Z, a - z, 0 - 9)  
Minus sign (-) and period (.)
- 4 **[User name]**  
Enter the user name for the POP server or the SMTP server.

- 5 **[Password]**  
Enter the password for the POP server or the SMTP server.
- 6 **[SMTP server port]**  
Enter the port number of the SMTP server. (Normally 25)
- 7 **[POP server port]**  
Enter the port number of the POP server. (Normally 110)
- 8 **[Submit]**  
Update the settings.

## Contents of mail sent

## Example of E-mail sent when E-mail is set

Mail with the contents shown below is sent when the e-mail settings have been established.

```

=== Panasonic projector report(CONFIGURE) ===
Projector Type       : PT-VW350
Serial No           : 000000000
----- E-mail setup data -----
TEMPERATURE WARNING SETUP
MINIMUM TIME        at [ 60] minutes interval
INTAKE AIR TEMPERATURE Over [ 32degC / 89degF ]

ERROR               [ OFF ]
LAMP RUNTIME        [ OFF ]   at REMAIN [ 400] H
LAMP RUNTIME        [ OFF ]   at REMAIN [ 200] H
INTAKE AIR TEMPERATURE [ OFF ]

----- check system -----
FAN                 [ OK ]
INTAKE AIR TEMPERATURE [ OK ]
EXHAUST AIR TEMPERATURE [ OK ]
OPTICS MODULE TEMPERATURE [ OK ]
LAMP REMAIN TIME    [ OK ]
LAMP STATUS         [ OK ]
APERTURE (CONTRAST-SHUTTER) [ OK ]
AIR FILTER          [ OK ]
(Error code 00 00 00 00 00 00 00 00)

Intake air temperature : 31 degC / 87 degF
Exhaust air temperature : 37 degC / 98 degF
Optics module temperature : 39 degC / 102 degF

PROJECTOR RUNTIME      800 H

LAMP NORMAL           500 H
LAMP ECO              700 H
LAMP REMAIN           4000 H
----- Current status -----
MAIN VERSION          1.00
NETWORK VERSION       1.00
SUB VERSION           1.00
LAMP STATUS           LAMP=ON
INPUT                 RGB
SIGNAL NAME           XGA6
SIGNAL FREQUENCY      0.00kHz / 0.00Hz

----- Wired Network configuration -----
DHCP Client           OFF
IP address            192.168.10.100
MAC address           04:20:9A:00:00:00

----- Memo -----

```

**Example of E-mail sent for an error**

Mail with the contents shown below is sent when an error has occurred.

```

=== Panasonic projector report(ERROR) ===
Projector Type       : PT-VW350
Serial No           : 000000000
----- check system -----
FAN                 [ OK ]
INTAKE AIR TEMPERATURE [ OK ]
EXHAUST AIR TEMPERATURE [ OK ]
OPTICS MODULE TEMPERATURE [ OK ]
LAMP REMAIN TIME    [ OK ]
LAMP STATUS         [ OK ]
APERTURE (CONTRAST-SHUTTER) [ OK ]
AIR FILTER          [ FAILED ]
(Error code 00 00 00 20 00 00 00 00)

Intake air temperature : 31 degC / 87 degF
Exhaust air temperature : 37 degC / 98 degF
Optics module temperature : 39 degC / 102 degF

PROJECTOR RUNTIME      800 H

LAMP NORMAL           500 H
LAMP ECO              700 H
LAMP REMAIN           4000 H

----- Current status -----
MAIN VERSION          1.00
NETWORK VERSION       1.00
SUB VERSION           1.00
LAMP STATUS           LAMP=OFF
INPUT                 RGB
----- Wired Network configuration -----
DHCP Client           OFF
IP address            192.168.10.100
MAC address           04:20:9A:00:00:00

----- Memo -----
    
```

**[Port set up] page**

Set the port number used for command control.  
 Click [Detailed set up] → [Port set up].

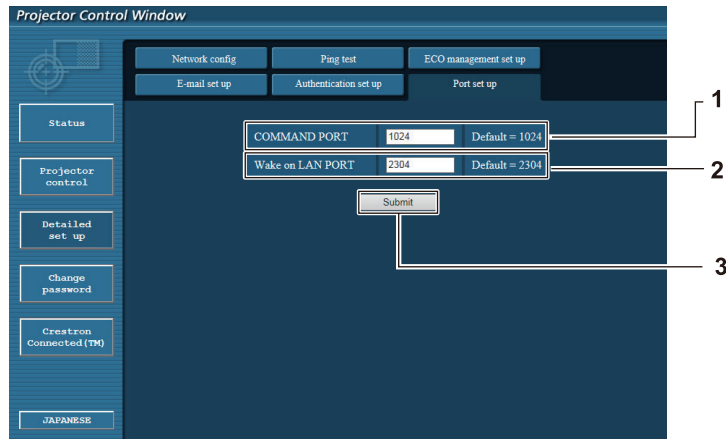

**1 [COMMAND PORT]**

Set the port number used for command control.

**2 [Wake on LAN PORT]**

When [STANDBY MODE] is set to [NETWORK], set the port number used for the Wake on LAN function.

**3 [Submit]**

Update the settings.

**[ECO management set up] page**

You can make settings for the ECO management function of the projector.  
Click [Detailed set up] → [ECO management set up].

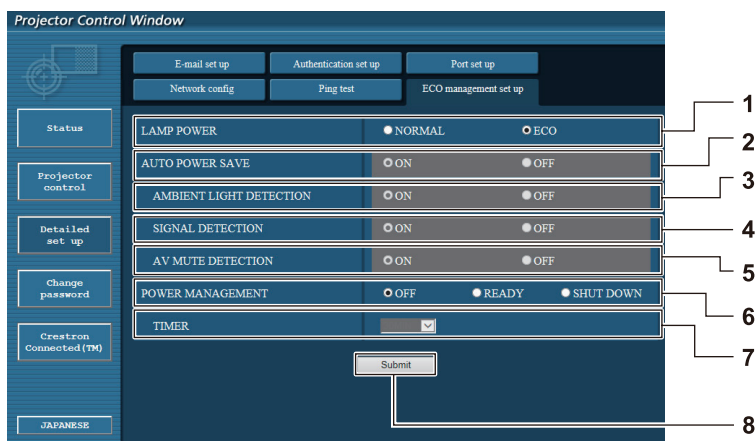

- |   |   |
|---|---|
| <p><b>1 [LAMP POWER]</b><br/>Selects the [LAMP POWER] setting.</p> <p><b>2 [AUTO POWER SAVE]</b><br/>Select [ON] to set [AMBIENT LIGHT DETECTION], [SIGNAL DETECTION], and [AV MUTE DETECTION].</p> <p><b>3 [AMBIENT LIGHT DETECTION]</b><br/>Enable ([ON])/disable ([OFF]) the ambient light detection function.</p> <p><b>4 [SIGNAL DETECTION]</b><br/>Enable ([ON])/disable ([OFF]) the signal detection function.</p> | <p><b>5 [AV MUTE DETECTION]</b><br/>Enable ([ON])/disable ([OFF]) the AV mute detection function.</p> <p><b>6 [POWER MANAGEMENT]</b><br/>Select the power consumption mode.</p> <p><b>7 [TIMER]</b><br/>Select the time that the lamp is turned off when the POWER MANAGEMENT function is using.</p> <p><b>8 [Submit]</b><br/>Update the setting.</p> |
|---|---|

**Note**

- For detailed description of each setting item, refer to the [PROJECTOR SETUP] menu of the projector → [ECO MANAGEMENT] (➔ page 71).

**[Change password] page**

Click [Change password].

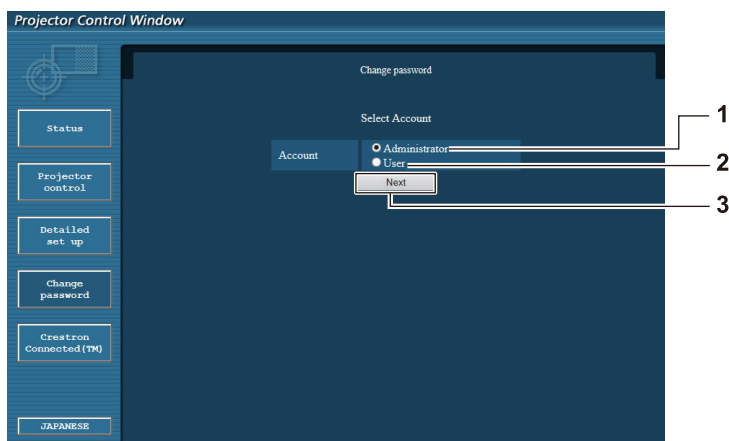

- |   |  |
|---|--|
| <p><b>1 [Administrator]</b><br/>Used to change the setting of [Administrator].</p> <p><b>2 [User]</b><br/>Used to change the setting of [User].</p> | <p><b>3 [Next]</b><br/>Used to change the setting of the password.</p> |
|---|--|

[Administrator] account

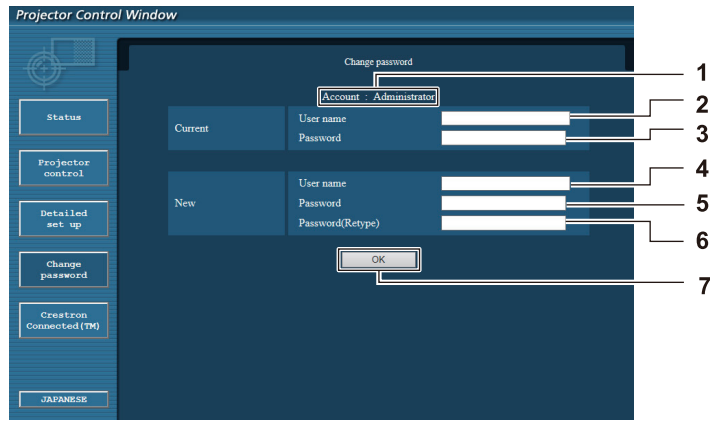

- 1 **[Account : Administrator]**  
Displays the account to change.
- 2 **[Current] [User name]**  
Enter the user name before the change.
- 3 **[Current] [Password]**  
Enter the current password.
- 4 **[New] [User name]**  
Enter the desired new user name.  
(Up to 16 characters in single byte)
- 5 **[New] [Password]**  
Enter the desired new password.  
(Up to 16 characters in single byte)
- 6 **[New] [Password (Retype)]**  
Enter the desired new password again.
- 7 **[OK]**  
Determines the change of password.

[User] account

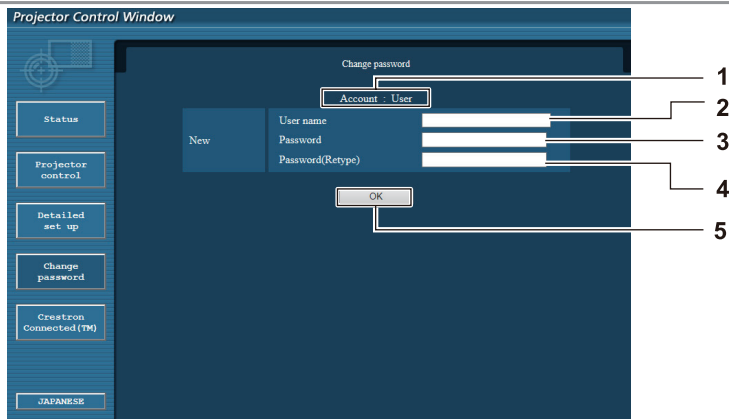

- 1 **[Account : User]**  
Displays the account to change.
- 2 **[New] [User name]**  
Enter the desired new user name.  
(Up to 16 characters in single byte)
- 3 **[New] [Password]**  
Enter the desired new password. (Up to 16 characters in single byte)
- 4 **[New] [Password (Retype)]**  
Enter the desired new password again.
- 5 **[OK]**  
Determines the change of password.

[Change password] (For user rights)

Only the change of password is enabled under the user rights.

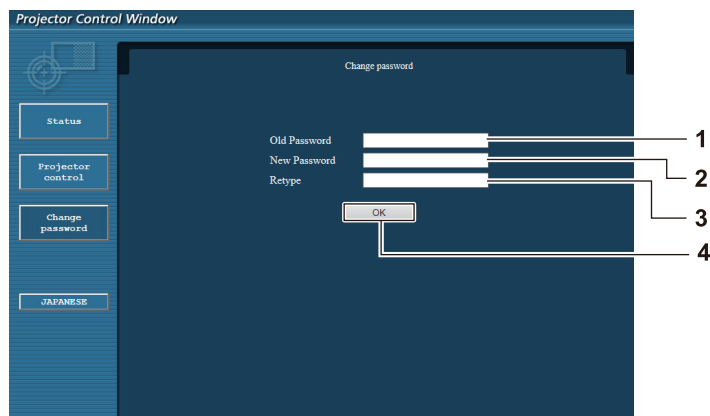

**1 [Old Password]**

Enter the current password.

**2 [New Password]**

Enter the desired new password. (Up to 16 characters in single byte)

**3 [Retype]**

Enter the desired new password again.

**4 [OK]**

Determines the change of password.

**Note**

- To change the account of the administrator, you must enter the [User name] and [Password] in [Current].

**[Crestron Connected(TM)] page**

The projector can be monitored/controlled with Crestron Connected™.

To start the Crestron Connected™ control page from the web control screen, you need to access with the administrator rights. (For user rights, the [Crestron Connected(TM)] button is not displayed on the web control screen.)

The control page of Crestron Connected™ is displayed by clicking [Crestron Connected(TM)].

It is not displayed if Adobe® Flash® Player is not installed on the computer used, or the browser used does not support Flash. In that case, click [Back] on the control page to go back to the previous page.

**Control page**

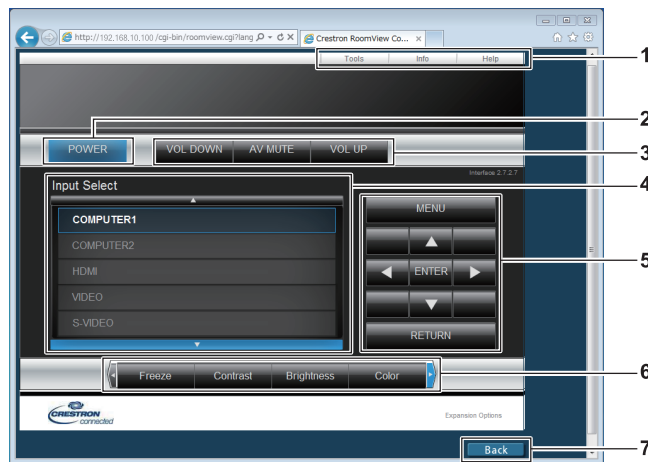

**1 [Tools], [Info], [Help]**

Tabs for selecting the setting, information or help page of the projector.

**2 [POWER]**

Turns on/off the power.

**3 [VOL DOWN], [AV MUTE], [VOL UP]**

Adjusts the volume.

Switches the AV mute function on/off.

**4 [Input Select]**

Controls input selection.

Not available when the power of the projector is turned off.

**5 Menu screen control buttons**

Navigates the menu screen.

**6 Freeze/image quality adjustment**

Controls items related to freeze/image quality.

**7 [Back]**

Performs return to the previous page.

**[Tools] page**

Click [Tools] on the control page.

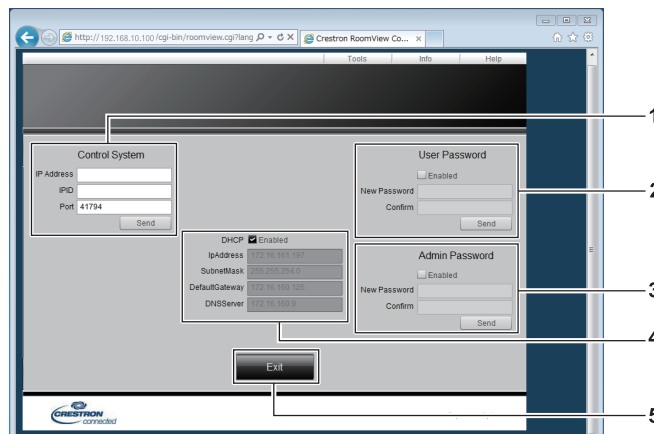

**1 [Control System]**

Set the information required for communicating with the controller to be connected with the projector.

**2 [User Password]**

Set the user rights password for the Crestron Connected™ control page.

**3 [Admin Password]**

Set the administrator rights password for the Crestron Connected™ control page.

**4 Network status**

Displays the settings of wired LAN.

**[DHCP]**

Displays the current setting.

**[IpAddress]**

Displays the current setting.

**[SubnetMask]**

Displays the current setting.

**[DefaultGateway]**

Displays the current setting.

**[DNSServer]**

Displays the current setting.

**5 [Exit]**

Returns to the control page.

**[Info] page**

Click [Info] on the control page.

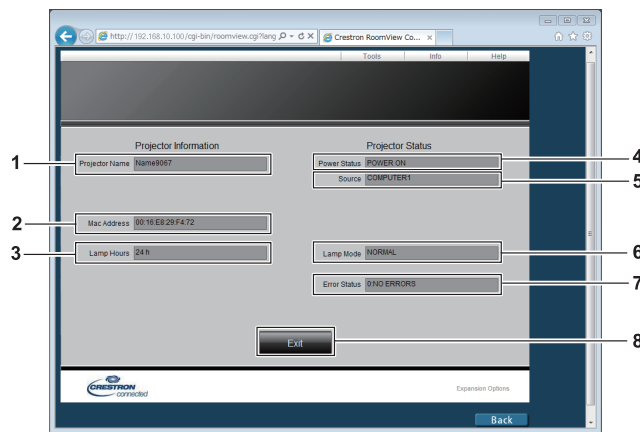

**1 [Projector Name]**

Displays the projector name.

**2 [Mac Address]**

Displays the MAC address.

**3 [Lamp Hours]**

Displays the runtime of the lamp (converted value).

**4 [Power Status]**

Displays the status of the power.

**5 [Source]**

Displays the selected input.

**6 [Lamp Mode]**

Displays the setting status of [LAMP POWER] (➔ page 71).

**7 [Error Status]**

Displays the error status.

**8 [Exit]**

Returns to the control page.

**[Help] page**

Click [Help] on the control page.

The [Help Desk] window is displayed.

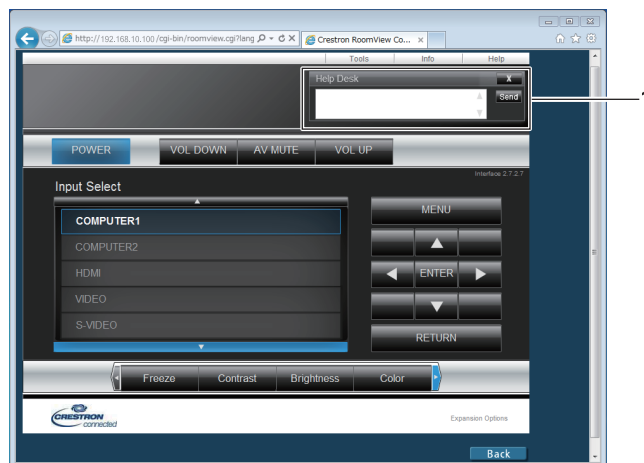

**1 [Help Desk]**

Send/receive messages to/from an administrator who uses Crestron Connected™.



# Chapter 5 Maintenance

---

This chapter describes methods of inspection when there are problems, maintenance, and replacement of the units.

# Lamp and Warning Indicators

## When an indicator lights up

If a problem should occur inside the projector, the lamp indicator <LAMP> and the warning indicator <WARNING> will inform you by lighting or blinking. Check the status of the indicators and remedy the indicated problems as follows.

### Attention

- Before you take a remedial measure, follow the procedure of switching the power off indicated in "Powering Off the projector". (➔ page 39)

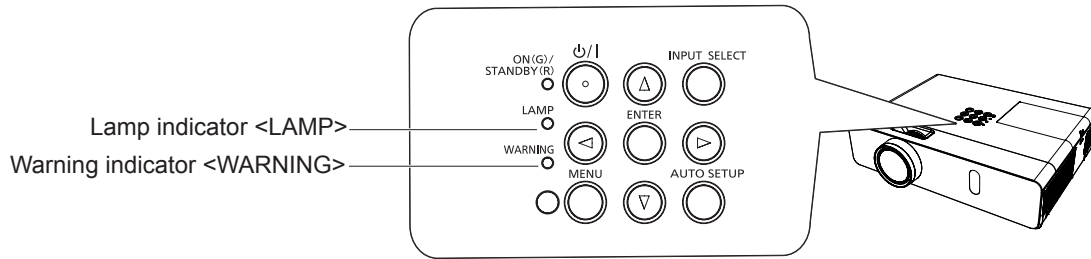

## Lamp indicator

Indicator	Lighting in red.	Blinking in red.
Status	Time to replace the lamp unit.	A problem is detected in the lamp or the power supply for the lamp.
Check	<ul style="list-style-type: none"> <li>• Was [REPLACE LAMP] displayed when you turned on the power?</li> <li>• The indicator lights up when the runtime of the lamp unit has reached 5 000 hours (when [LAMP POWER] is set to [NORMAL]).</li> </ul>	<ul style="list-style-type: none"> <li>• Have you turned on the power again immediately after turning it off?</li> <li>• Some error has occurred in the lamp circuit. Check for fluctuation (or drop) in the source voltage.</li> </ul>
Remedy	<ul style="list-style-type: none"> <li>• Replace the lamp unit.</li> </ul>	<ul style="list-style-type: none"> <li>• Wait a while until the luminous lamp cools off, and then turn on the power.</li> <li>• Turn off the projector, and unplug the AC power cord, and consult your dealer.</li> </ul>

### Note

- If the lamp indicator <LAMP> is still lighting or blinking after taking the preceding measures, ask your dealer for repair.

## Warning indicator

Indicator	Lighting in red.	Blinking in red.	Blinking in red. (Slow)
Status	Internal temperature is high (warning).	Internal temperature is high (standby status).	The projector detects an abnormal condition and cannot be turned on.
Check	<ul style="list-style-type: none"> <li>• Is the air intake/exhaust port blocked?</li> <li>• Is the room temperature high?</li> <li>• Is the air filter unit dirty?</li> </ul>		
Remedy	<ul style="list-style-type: none"> <li>• Remove any objects that are blocking the air intake / exhaust port.</li> <li>• Install the projector in a location with an ambient temperature of 0 °C (32 °F) to 40 °C (104 °F).</li> <li>• Do not use the projector at high altitudes of 2 700 m (8 858') or higher above sea level.</li> <li>• Replace the air filter unit. (➔ page 99)</li> </ul>		<ul style="list-style-type: none"> <li>• If the projector is turned off again, unplug the AC power cord and contact the dealer or the service center for service and checkup.</li> </ul>

### Note

- If the warning indicator <WARNING> is still lighting or blinking after taking the preceding measures, ask your dealer for repair.

# Maintenance/replacement

## Before performing maintenance/replacement

- When you perform maintenance or replacement of the parts, make sure to turn off the power and disconnect the power plug from the wall outlet. (➔ pages 35, 39)
- Be sure to observe the procedure “Powering Off the projector” (➔ page 39) when performing power supply operation.

## Maintenance

### Outer Case

Wipe off dirt and dust using a soft dry cloth.

- If the dirt is persistent, soak the cloth with water and wring it thoroughly before wiping. Dry off the projector with a dry cloth.
- Do not use benzene, thinner or rubbing alcohol, other solvents or household cleaners. Using them may cause deterioration of the outer case.
- When using chemical treated dusters, follow its instruction.

### Front glass surface of the lens

Wipe off the dirt and dust off the front surface of the lens with soft clean cloth.

- Do not use a cloth that has an abrasive surface or a cloth that is moist, oily or covered with dust.
- Do not use excessive force when wiping the lens as it is fragile.
- Do not use benzene, thinner or rubbing alcohol, other solvents or household cleaners. Using them may cause deterioration of the lens.

### Attention

- The lens is made of glass. Impacts or excessive force when wiping may scratch its surface.  
Please handle with care.

## Replacing the unit

### Air filter unit

The air filter prevents dust from accumulating on the optical elements inside the projector. Should the air filter become clogged with dust particles, it will reduce cooling fans' effectiveness and may result in internal heat buildup and adversely affect the life of the projector.

If the air filter unit become clogged, it will result in internal heat buildup, the power of the projector may be turned off for safety. If a warning message appears on the screen, replace the air filter immediately.

Consult your dealer to purchase a replacement air filter unit (ET-RFV300).

### Removing the air filter unit

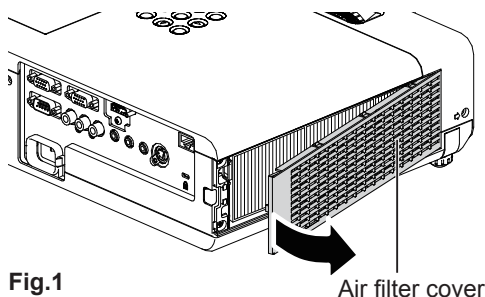

Fig.1

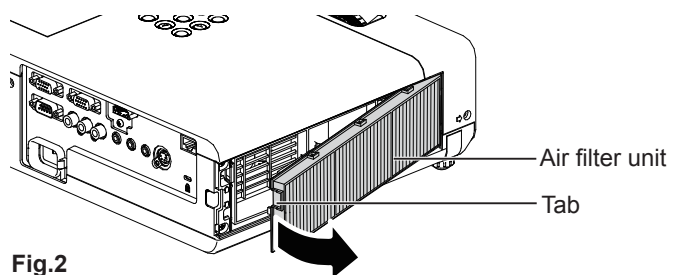

Fig.2

#### 1) Remove the air filter cover. (Fig.1)

- Open the air filter cover in the direction of the arrow and remove it.

#### 2) Remove the air filter unit.

- Hold the tab of the air filter unit and pull out in the direction of the arrow. (Fig.2)
- After removing the air filter unit, remove foreign objects and dust from the air filter compartment and the projector's air intake port if there are any.

### Attaching the air filter unit

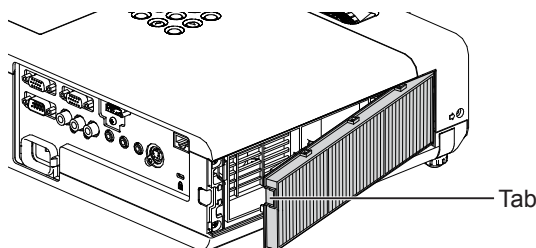

#### 1) Attach the unused air filter unit to the projector.

- Hold the air filter unit that the tab is in up-left side in the figure, put the right side in the figure first, and press the tab side until make a click sound.
- Please press the tab of the air filter unit other than the pleated filter during installation.

#### 2) Install the air filter cover.

- Perform Step 1) in "Removing the air filter unit" (➔ page 99) in the reverse order to close the air filter cover and press it firmly until make a click sound.
- Make sure that the air filter cover is closed tightly.

### Resetting the filter counter

Be sure to reset the filter counter after replacing the air filter unit.

- 1) **Connect the power plug, press the power <⏻/⏪> button on the control panel or on the remote control.**
- 2) **Press the <MENU> button to display the main menu, then press ▲▼ to select [PROJECTOR SETUP].**
- 3) **Press the <ENTER> button, press ▲▼ to select [FILTER COUNTER].**
- 4) **Press the <ENTER> button, press ▲▼ to select [FILTER COUNTER RESET].**
- 5) **Press the <ENTER> button.**
  - [FILTER COUNTER RESET] confirmation is displayed.
- 6) **Press ◀▶ to select [OK], then press the <ENTER> button.**
  - The filter usage time is 0 after reset.

### Attention

- Turn off the power before you replace the air filter unit.
- When attaching the air filter unit, make sure that the projector is stable, and work in an environment that is safe, even in the event of the air filter unit dropping.
- Make sure that the air filter unit is properly attached before using the projector. If it is not attached, the projector will suck in dirt and dust causing a malfunction.
- Do not put anything into the air vents. Doing so may result in malfunction of the projector.
- The air filter unit to be replaced should be an unused product.
- After replacing the air filter, reset the filter counter. Otherwise, "FILTER COUNTER has reached the set time." will appear on screen.

### Note

- The replacement cycle of the air filter unit varies greatly depending on the usage environment.

### Lamp unit

The lamp unit is a consumable component.

Refer to "When to replace the lamp unit" (➔ page 101) for details about the replacement cycle.

It is recommended to ask an authorized engineer to replace the lamp unit. Contact your dealer.

Consult your dealer to purchase a replacement lamp unit (ET-LAV300).

## Warning

**Do not replace the lamp unit when it is hot. (Wait at least 1 hour after use.)**

The inside of the cover can become very hot, take care to avoid burn injuries.

**Notes on the replacement of the lamp unit**

- The luminous source of the lamp is made of glass and may burst if you hit it against a hard surface or drop it. Please handle with care.
- A Phillips screwdriver is required for replacement of the lamp unit.
- When replacing the lamp unit, be sure to hold it by the handle.
- When replacing the lamp because it has stopped illuminating, there is a possibility that the lamp may be broken. If replacing the lamp of a projector which has been installed on the ceiling, you should always assume that the lamp is broken, and you should stand to the side of the lamp cover, not underneath it. Remove the lamp cover gently. Small pieces of glass may fall out when the lamp cover is opened. If pieces of glass get into your eyes or mouth, seek medical advice immediately.
- The lamp may be ruptured. Care should be taken not to scatter pieces of the broken lamp glass when replacing the lamp unit. Pieces of the broken lamp may fall from the lamp unit especially when the projector is mounted on the ceiling, so when replacing the lamp unit do not stand directly underneath it or position your face close to it.
- The lamp contains mercury. Consult your local municipality or your dealer about correct disposal of used lamp units.

**Attention**

- Panasonic takes no responsibility for any damage or malfunction of the product resulting from use of lamp units which are not manufactured by Panasonic. Use only specified lamp units.

**Note**

- The model numbers of accessories and optional accessories are subject to change without prior notice.

**When to replace the lamp unit**

The lamp unit is a consumable component. Since its brightness gradually decreases over time, it is necessary to replace the lamp unit regularly. The estimated duration before replacement is 5 000 hours, but the lamp may go off before 5 000 hours has elapsed depending on individual lamp characteristics, usage conditions, and the installation environment. It is recommended that the Replacement lamp unit be prepared earlier.

If you continue to use the lamp unit after 5 000 hours has elapsed, the lamp turns off automatically after approximately 10 minutes, as it will cause malfunction of the projector.

Lamp runtime	On-screen display REPLACE LAMP	LAMP indicator
Over 4 800 hours	The message is displayed for 30 seconds. If you press any button within the 30 seconds, the message disappears.	Lights in red (even in stand-by mode).
Over 5 000 hours	If the power is turned on without replacing the lamp, the power automatically turns off after approximately ten minutes to prevent the malfunction of the projector.	

**Note**

- To predict when to replace the lamp, check the lamp runtime displayed in [RUNTIME] in [STATUS] (▶ page 69).
- 5 000 hours of use is a rough guideline, but is not a guarantee. The lamp runtime differs depending on the setting of "LAMP POWER" menu.

**Replacing the Lamp unit**

**Attention**

- When the projector is mounted on a ceiling, do not work with your face close to the projector.
- Do not loosen other than designated screws.
- Attach the lamp unit and the lamp cover securely.

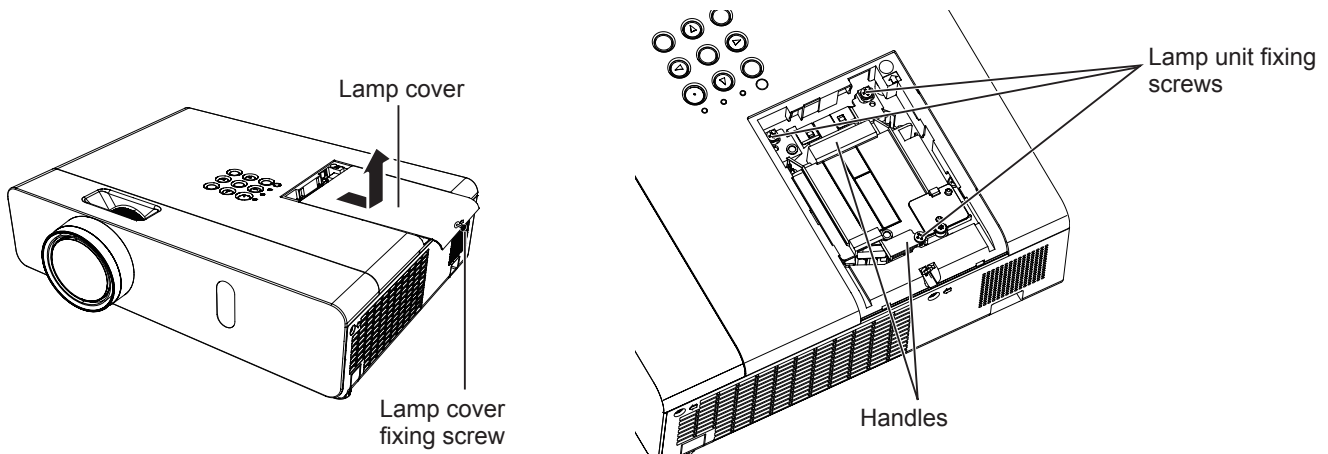

- 1) **Turn off the Power by following the procedure in "Powering Off the Projector". (➔ page 39)**  
**Remove the AC power plug from the wall outlet.**
  - Wait at least 1 hour and make sure the lamp unit and surroundings are cool.
- 2) **Use a Phillips screwdriver to loosen the lamp cover fixing screw (×1) until it turns freely and remove the lamp cover.**
  - Remove the lamp cover by pulling it slowly toward the direction of the arrow.
- 3) **Use a Phillips screwdriver to loosen the three lamp unit fixing screws (×3) until they turn freely.**
- 4) **Hold the used lamp unit by its handles, and pull it gently from the projector.**
- 5) **Insert the new lamp unit in correct direction. Tighten the three lamp unit fixing screws (×3) securely with a Phillips screwdriver.**
  - When you experience difficulty in installing the lamp unit, remove it and try again. If you use force to install the lamp unit, the connector may be damaged.
- 6) **Attach the lamp cover. Tighten the lamp cover fixing screw (×1) securely with a Phillips screwdriver.**
  - Perform Step 2) in the reverse order to attach the lamp cover.

---

**Note**

- When you replace the lamp unit with new one, the projector resets the runtime of the lamp unit automatically.

# Troubleshooting

Please check following points. For details, see the corresponding pages.

Problem	Cause	Reference page
<b>Power does not turn on.</b>	<ul style="list-style-type: none"> <li>The power cord may not be connected.</li> <li>No electric supply is at the wall outlet.</li> <li>The circuit breakers have tripped.</li> <li>Is the lamp indicator &lt;LAMP&gt; or the warning indicator &lt;WARNING&gt; indicator lit or blinking?</li> <li>The lamp cover has not been securely installed.</li> </ul>	— — — 98 101
<b>No picture appears.</b>	<ul style="list-style-type: none"> <li>The video signal input source may not be connected to a terminal properly.</li> <li>The input selection setting may not be correct.</li> <li>The [BRIGHTNESS] adjustment setting may be at the minimum setting.</li> <li>The input source which is connected to the projector may have a problem.</li> <li>The AV MUTE function may be in use.</li> </ul>	32 40 52 — 43, 68
<b>The picture is fuzzy.</b>	<ul style="list-style-type: none"> <li>The lens cap is still attached to the lens.</li> <li>The lens focus may not have been set correctly.</li> <li>The projector may not be at the correct distance from the screen.</li> <li>The lens may be dirty.</li> <li>The projector may be tilted too much.</li> </ul>	17 40 27 16 —
<b>The color is pale or grayish.</b>	<ul style="list-style-type: none"> <li>[COLOR] or [TINT] adjustment may be incorrect.</li> <li>The input source which is connected to the projector may not be adjusted correctly.</li> <li>RGB cable is damaged.</li> </ul>	52 — —
<b>No sound from the internal speaker.</b>	<ul style="list-style-type: none"> <li>The input terminals may not have been correctly connected.</li> <li>The volume may have been set to the minimum level.</li> <li>The AV MUTE function may have been turned on.</li> <li>When the VARIABLE AUDIO OUT is plugged-in, the projector's built-in speaker is not available.</li> <li>The MUTE function may have been turned on.</li> <li>Is the audio input selection in [AUDIO SETTING] set correctly?</li> </ul>	33 44, 73 43, 68 33 44, 73 74
<b>The remote control does not operate.</b>	<ul style="list-style-type: none"> <li>The batteries may be weak.</li> <li>The batteries may not have been inserted correctly.</li> <li>The remote control signal receptor on the projector may be obstructed.</li> <li>The remote control unit may be out of the operation range.</li> <li>Strong light such as fluorescent shine onto the signal receptor.</li> <li>The [REMOTE CONTROLLER] setting is set to [DISABLE] in [CONTROL DEVICE SETUP].</li> <li>Is the ID number setting operation correct?</li> </ul>	— 23 20 20 20 78 45
<b>Menu screen does not appear.</b>	<ul style="list-style-type: none"> <li>Is the on-screen display function turned off (hidden)?</li> </ul>	62
<b>The control buttons of the projector do not operate.</b>	<ul style="list-style-type: none"> <li>The [CONTROL PANEL] setting is set to [DISABLE] in [CONTROL DEVICE SETUP].</li> </ul>	78
<b>The picture does not display correctly.</b>	<ul style="list-style-type: none"> <li>There may be a problem with the VCR or other signal source.</li> <li>A signal which is not compatible with the projector is being input.</li> </ul>	— 112
<b>Picture from a computer does not appear.</b>	<ul style="list-style-type: none"> <li>The cable may be longer than the optional cable.</li> <li>The external video output from a laptop computer may not be correct.</li> </ul>	— —
<b>Picture from a HDMI device does not appear or picture is not stable.</b>	<ul style="list-style-type: none"> <li>Is the HDMI cable securely connected?</li> <li>Turn off the power of the projector and the connected devices. Then turn the power of the projector and the connected devices back on.</li> <li>Isn't unsupported signal cable connected?</li> </ul>	32, 33 — 112
<b>No sound is output from a HDMI device.</b>	<ul style="list-style-type: none"> <li>Set the sound channel of the attached device to Linear PCM.</li> </ul>	—

## Attention

- If the problem persists, after confirming the contents of the table, please consult your dealer.

# Chapter 6 Appendix

---

This chapter describes specifications and after-sales service for the projector.



# Technical Information

## PJLink protocol

The network function of the projector supports PJLink class 1, and the PJLink protocol can be used to perform projector setting and projector status query operations from a computer.

### Control commands

The following table lists the PJLink protocol commands that can be used to control the projector.

- x characters in tables are non-specific characters.

Command	Control details	Parameter / return string	Remark		
POWR	Power supply control	0 1	Standby Power on		
POWR ?	Power supply status query	0 1 2 3	Standby Power on Cool-down in progress Warm-up in progress		
INPT	Input selection	11	RGB 1		
INPT ?	Input selection query	12 21 22 31	RGB 2 VIDEO S-VIDEO HDMI		
AVMT	AV MUTE control	30	AV MUTE mode off		
AVMT ?	AV MUTE status query	31	AV MUTE mode on		
ERST ?	Error status query	xxxxxx	1st byte	Indicates fan errors, range 0 – 2.	<ul style="list-style-type: none"> <li>• 0 = No error is detected</li> <li>• 1 = Warning</li> <li>• 2 = Error</li> </ul>
			2nd byte	Indicates lamp errors, range 0 – 2	
			3rd byte	Indicates temperature errors, range 0 – 2.	
			4th byte	Fixed at 0.	
			5th byte	Indicates filter errors, range 0 – 2.	
			6th byte	Indicates other errors, range 0 – 2.	
LAMP ?	Lamp status query	xxxxxxxxxxx	1st digits (1 – 5 digits) : Lamp cumulative operating time 2nd digit : 0 = Lamp off, 1 = Lamp on		
INST ?	Input selection list query	11 12 21 22 31			
NAME ?	Projector name query	xxxxx	Returns the name set in [NAME CHANGE] of [NETWORK].		
INF1 ?	Manufacturer name query	Panasonic	Returns manufacturer name.		
INF2 ?	Model name query	VW350 VX420	Returns model name.		
INF0 ?	Other information query	xxxxx	Returns information such as version number.		
CLSS ?	Class information query	1	Returns class for PJLink.		

### PJLink security authorization

The password used for PJLink is the same as that of the password set for web control.

When using the projector without security authentication, do not set a password for web control.

- For specifications related to PJLink, refer to the website of Japan Business Machine and Information System Industries Association.

URL <http://pjlink.jbmia.or.jp/english/>

## Control commands via LAN

### When WEB Control administrator rights password is set (Protect mode)

#### Connection method

- 1) Obtain the IP address and port number (Initial set value = 1 024) of the projector and make a request for connection to the projector.

- Acquire the IP address from the menu screen of the projector, and the port number from the WEB control page.

<b>IP address :</b>	Obtain from MAIN MENU → [NETWORK] → [STATUS]
<b>Port No. :</b>	Acquire from the WEB control → [Detailed set up] → [Port set up] page

- 2) There is a response from the projector.

	Data section	Blank	Mode	Blank	Random number section	Termination symbol
<b>Command example</b>	"NTCONTROL" (ASCII string)	' '	'1'	' '	"ZZZZZZZ" (ASCII code hexadecimal number)	(CR) 0x0d
<b>Data length</b>	9 bytes	1 byte	1 byte	1 byte	8 bytes	1 byte

- Mode : 1 = Protect mode

- 3) Generate a 32-byte hash value from the following data using MD5 algorithm.

- "xxxxxx:yyyyy:zzzzzzz"

<b>xxxxxx :</b>	Administrator rights user name for WEB CONTROL (Default user name is "admin1")
<b>yyyyy :</b>	Password of above administrator rights user (Default password is "panasonic")
<b>zzzzzzz :</b>	8-byte random number obtained in Step 2

#### Command transmission method

Transmit using the following command format.

##### ■ Transmitted data

	Header			Data section	Termination symbol
<b>Command example</b>	Hash value (See above <Connection method>)	'0' 0x30	'0' 0x30	Control command (ASCII string)	(CR) 0x0d
<b>Data length</b>	32 bytes	1 byte	1 byte	Undefined length	1 byte

##### ■ Receive data

	Header		Data section	Termination symbol
<b>Command example</b>	'0' 0x30	'0' 0x30	Control command (ASCII string)	(CR) 0x0d
<b>Data length</b>	1 byte	1 byte	Undefined length	1 byte

##### ■ Error response

	String	Details	Termination symbol
<b>Message</b>	"ERR1"	Undefined control command	(CR) 0x0d
	"ERR2"	Out of parameter range	
	"ERR3"	Busy state or no-acceptable period	
	"ERR4"	Timeout or no-acceptable period	
	"ERR5"	Wrong data length	
	"ERRA"	Password mismatch	
<b>Data length</b>	4 bytes	—	1 byte

## When WEB Control administrator rights password is not set (Non-protect mode)

### Connection method

- 1) Obtain the IP address and port number (Initial set value = 1 024) of the projector and make a request for connection to the projector.

- Acquire the IP address from the menu screen of the projector, and the port number from the WEB control page.

IP address :	Obtain from main menu → [NETWORK] → [STATUS]
Port No. :	Acquire from the WEB control → [Detailed set up] → [Port set up] page

- 2) There is a response from the projector.

### Response data

	Data section	Blank	Mode	Termination symbol
Command example	"NTCONTROL" (ASCII string)	' '	'0'	(CR)
Data length	9 bytes	0x20	0x30	0x0d
		1 byte	1 byte	1 byte

- Mode : 0 = Non-protect mode

### Command transmission method

Transmit by the following command format.

### Transmitted data

	Header		Data section	Termination symbol
Command example	'0'	'0'	Control command (ASCII string)	(CR)
Data length	0x30	0x30	Undefined length	0x0d
	1 byte	1 byte		1 byte

### Receive data

	Header		Data section	Termination symbol
Command example	'0'	'0'	Control command (ASCII string)	(CR)
Data length	0x30	0x30	Undefined length	0x0d
	1 byte	1 byte		1 byte

### Response data

	String	Details	Termination symbol
Message	"ERR1"	Undefined control command	(CR) 0x0d
	"ERR2"	Out of parameter range	
	"ERR3"	Busy state or no-acceptable period	
	"ERR4"	Timeout or no-acceptable period	
	"ERR5"	Wrong data length	
	"ERRA"	Password mismatch	
Data length	4 bytes	—	1 byte

## Serial terminal

The serial connector which is on the connector panel of the projector conforms to the RS-232C interface specification, so that the projector can be controlled by a personal computer which is connected to this connector.

### Connection

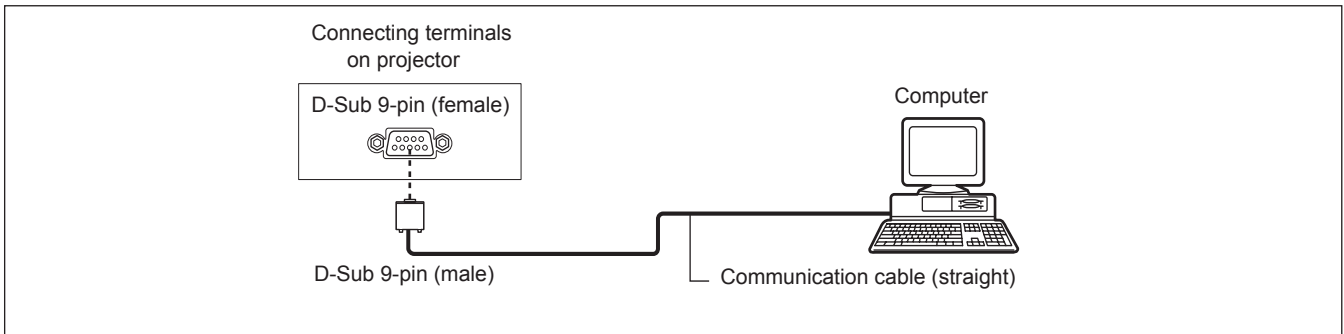

### Pin assignments and signal names

D-Sub 9-pin (female) Outside view	Pin No.	Signal name	Contents
		①	—
②		TXD	Transmitted data
③		RXD	Received data
④		—	NC
⑤		GND	Earth
⑥		—	NC
⑦		CTS	Connected internally
⑧		RTS	
⑨		—	NC

### Communication conditions (Factory default)

<b>Signal level</b>	RS-232C-compliant
<b>Sync. method</b>	Asynchronous
<b>Baud rate</b>	9 600 bps
<b>Parity</b>	None
<b>Character length</b>	8 bits
<b>Stop bit</b>	1 bit
<b>X parameter</b>	None
<b>S parameter</b>	None

**Basic format**

Transmission from the computer starts with STX, then the ID, command, parameter, and ETX are sent in this order. Add parameters according to the details of control.

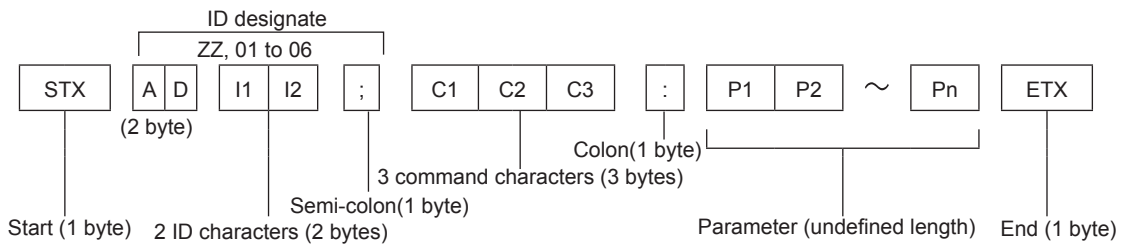

**Basic format (with sub command)**

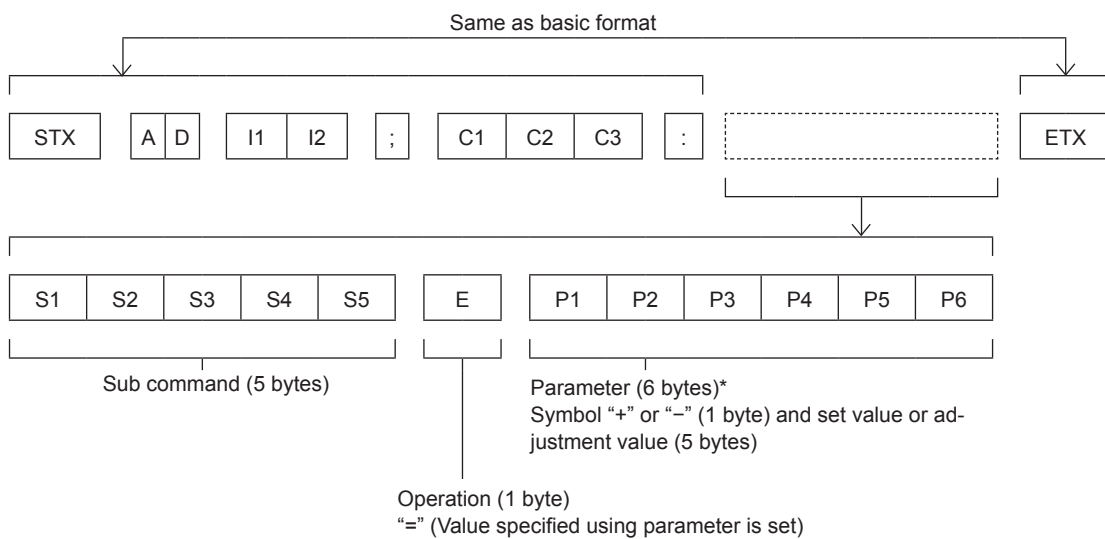

\* When transmitting a command which does not need a parameter, the operation (E) and parameter are not necessary.

**Attention**

- If a command is transmitted after the lamp starts illuminating, there may be a delay in response or the command may not be executed. Try sending or receiving any command after 60 seconds.
- When transmitting multiple commands, be sure to wait until 0.5 seconds has elapsed after receiving the response from the projector before sending the next command. When transmitting a command which does not need a parameter, a colon (:) is not necessary.

**Note**

- If a command cannot be executed, the "ER401" response is sent from the projector to the computer.
- If an invalid parameter is sent, the "ER402" response is sent from the projector to the computer.
- ID transmission in RS-232C supports ZZ (ALL) and 01 to 06.
- If a command is sent with a specified ID, a response will be sent to the computer only in the following cases.
  - It matches the projector ID.
  - [PROJECTOR ID] (➔ page 69) is set to [ALL].
- STX and ETX are character codes. STX shown in hexadecimal is 02, and ETX shown in hexadecimal is 03.

## Cable specifications

[When connected to a computer]

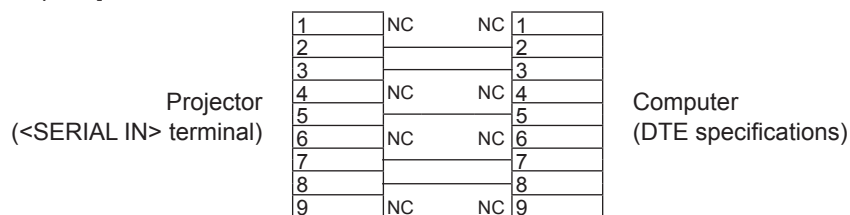

## Control commands

When controlling the projector from a computer, the following commands are available.

### ■ Projector control command

Command	Control contents	Parameter / return string	Remarks
PON	Power on	—	To check if the power is on, use the “Power query” command.
POF	Power off		
IIS	INPUT selection	VID SVD RG1 RG2 HD1	VIDEO S-VIDEO RGB1 RGB2 HDMI
OSH	AV mute function	0 1	AV MUTE mode off AV MUTE mode on
OFZ	Freeze	0	[OFF]
		1	[ON]
AUU	Volume up		
AUD	Volume down		
DZU	D. ZOOM up		
DZD	D. ZOOM down		
QPW	Power query	000	Standby
		001	Power on
Q\$\$	Lamp condition query	0	Stand-by
		1	Lamp ON control active
		2	Lamp ON
		3	Lamp OFF control active

## [MENU LOCK PASSWORD] operations

To initialize your password, consult your distributor.

## Two window display combination list

		Sub Window					
		COMPUTER1		COMPUTER2	HDMI	VIDEO	S-VIDEO
Main Window		RGB	Y C <sub>B</sub> C <sub>R</sub> / Y P <sub>B</sub> P <sub>R</sub>	RGB			
COMPUTER1	RGB	—	—	—	✓	—	—
	Y C <sub>B</sub> C <sub>R</sub> / Y P <sub>B</sub> P <sub>R</sub>	—	—	—	✓	—	—
COMPUTER2	RGB	—	—	—	✓	—	—
HDMI		✓	✓	✓	—	✓	✓
VIDEO		—	—	—	✓	—	—
S-VIDEO		—	—	—	✓	—	—

✓ : Picture in Picture combinations are enabled.

—: Picture in Picture combinations are disabled.

### Note

- When setting the movie-based signal 1080/24p, 1080/24sF, 1080/25p, 1080/30p, 1080/50p or 1080/60p for HDMI input, the two window display function will be disabled.
- The image of the sub window picture may be distorted depending on the combination of signals.
- When the selected input combinations or the input signals are not correspond with the two window display, the message "CANNOT DISPLAY THIS INPUT COMBINATION IN P IN P" will be displayed.

## List of compatible signals

The following table specifies the type of signals compatible with the projectors.

- Symbols that indicate formats are as follows.

V = VIDEO, S = S-VIDEO, R = RGB, Y = YCbCr/YPbPr, H = HDMI

Mode	Display resolution (dots)	Scanning frequency		Dot clock frequency (MHz)	Format*1	PnP*2	
		H (kHz)	V (Hz)			COMPUTER1 / COMPUTER2	HDMI
NTSC/NTSC4.43/ PAL-M/PAL60	720 x 480i	15.7	59.9	—	V/S	—	—
PAL/PAL-N/SECAM	720 x 576i	15.6	50.0	—	V/S	—	—
525i (480i)	720 x 480i	15.7	59.9	13.5	R/Y	—	—
625i (576i)	720 x 576i	15.6	50.0	13.5	R/Y	—	—
525i (480i)	720 (1 440) x 480i <sup>13</sup>	15.7	59.9	27.0	H	—	—
625i (576i)	720 (1 440) x 576i <sup>13</sup>	15.6	50.0	27.0	H	—	—
525p (480p)	720 x 483	31.5	59.9	27.0	R/Y/H	—	✓
625p (576p)	720 x 576	31.3	50.0	27.0	R/Y/H	—	✓
750 (720) /60p	1 280 x 720	45.0	60.0	74.3	R/Y/H	—	✓
750 (720) /50p	1 280 x 720	37.5	50.0	74.3	R/Y/H	—	✓
1125 (1080) /60i <sup>14</sup>	1 920 x 1 080i	33.8	60.0	74.3	R/Y/H	—	✓
1125 (1080) /50i	1 920 x 1 080i	28.1	50.0	74.3	R/Y/H	—	✓
1125 (1080) /24p	1 920 x 1 080	27.0	24.0	74.3	R/Y/H	—	✓
1125 (1080) /24sF	1 920 x 1 080i	27.0	48.0	74.3	R/Y/H	—	—
1125 (1080) /25p	1 920 x 1 080	28.1	25.0	74.3	R/Y/H	—	—
1125 (1080) /30p	1 920 x 1 080	33.8	30.0	74.3	R/Y/H	—	—
1125 (1080) /60p	1 920 x 1 080	67.5	60.0	148.5	R/Y/H	—	✓
1125 (1080) /50p	1 920 x 1 080	56.3	50.0	148.5	R/Y/H	—	✓
VESA400	640 x 400	31.5	70.1	25.2	R/H	—	—
	640 x 400	37.9	85.1	31.5	R/H	—	—
VGA	640 x 480	31.5	59.9	25.2	R/H	✓	✓
	640 x 480	35.0	66.7	30.2	R/H	✓	—
	640 x 480	37.9	72.8	31.5	R/H	✓	—
	640 x 480	37.5	75.0	31.5	R/H	✓	—
	640 x 480	43.3	85.0	36.0	R/H	—	—
SVGA	800 x 600	35.2	56.3	36.0	R/H	✓	—
	800 x 600	37.9	60.3	40.0	R/H	✓	✓
	800 x 600	48.1	72.2	50.0	R/H	✓	—
	800 x 600	46.9	75.0	49.5	R/H	✓	—
	800 x 600	53.7	85.1	56.3	R/H	—	—
MAC16	832 x 624	49.7	74.6	57.3	R/H	✓	—
XGA	1 024 x 768	39.6	50.0	51.9	R/H	—	—
	1 024 x 768	48.4	60.0	65.0	R/H	✓	✓
	1 024 x 768	56.5	70.1	75.0	R/H	✓	—
	1 024 x 768	60.0	75.0	78.8	R/H	✓	—
	1 024 x 768	65.5	81.6	86.0	R/H	—	—
	1 024 x 768	68.7	85.0	94.5	R/H	—	—
	1 024 x 768	81.4	100.0	113.3	R/H	—	—
MXGA	1 152 x 864	64.0	70.0	94.2	R/H	—	—
	1 152 x 864	67.5	75.0	108.0	R/H	—	—
	1 152 x 864	77.1	85.0	119.7	R/H	—	—
MAC21	1 152 x 870	68.7	75.1	100.0	R/H	—	—
1280 x 720	1 280 x 720	37.1	50.0	60.5	R/H	—	—
	1 280 x 720	44.8	60.0	74.5	R/H	—	—
1280 x 768	1 280 x 768	60.3	74.9	102.3	R/H	—	—
	1 280 x 768	68.6	84.8	117.5	R/H	—	—



Mode	Display resolution (dots)	Scanning frequency		Dot clock frequency (MHz)	Format*1	PnP*2	
		H (kHz)	V (Hz)			COMPUTER1 / COMPUTER2	HDMI
1280 x 800	1 280 x 800	41.3	50.0	68.0	R/H	—	—
	1 280 x 800	49.7	59.8	83.5	R/H	✓	✓
MSXGA	1 280 x 960	60.0	60.0	108.0	R/H	—	—
SXGA	1 280 x 1 024	64.0	60.0	108.0	R/H	✓	✓
	1 280 x 1 024	80.0	75.0	135.0	R/H	✓	—
	1 280 x 1 024	91.1	85.0	157.5	R/H	—	—
1366 x 768	1 366 x 768	39.6	49.9	69.0	R/H	—	—
	1 366 x 768	47.7	59.8	85.5	R/H	✓	✓
SXGA+	1 400 x 1 050	65.2	60.0	122.6	R/H	—	—
	1 400 x 1 050	82.3	74.9	156.0	R/H	—	—
WXGA+	1 400 x 900 <sup>*5</sup>	55.5	59.9	88.8	R/H	—	—
1600 x 900	1 600 x 900	46.3	50.0	97.0	R/H	—	—
	1 600 x 900	55.9	60.0	119.0	R/H	✓	✓
UXGA	1 600 x 1 200	75.0	60.0	162.0	R/H	✓	✓
WSXGA+	1 680 x 1 050	65.2	60.0	147.1	R/H	✓	✓
1920 x 1080	1 920 x 1 080 <sup>*5</sup>	66.6	59.9	138.5	R/H	—	—
WUXGA	1 920 x 1 200 <sup>*5</sup>	74.0	60.0	154.0	R/H	—	—

\*1 <COMPUTER 2 IN> terminal is only for RGB signals input.

\*2 Where marked "✓" signals indicates in Plug and Play is compatible with EDID of projector. Unmarked signals in Plug and Play may also be compliant if input terminals are written in the format list. Where Plug and Play is unmarked and nothing is written in the format list, difficulties in projecting image may occur even when computer and projector appear to have same resolution.

\*3 Pixel-Repetition signal (dot clock frequency 27.0 MHz) only

\*4 When a 1125 (1035)/60i signal was input, it is displayed as a 1125 (1080)/60i signal.

\*5 VESA CVT-RB (Reduced Blanking)-compliant.

#### Note

- The number of display dots is 1 280 x 800 for the PT-VW350 and 1 024 x 768 for the PT-VX420.  
A signal with a different resolution will be projected after converting the resolution to match the projector display.
- "i" added to the resolution value indicates an interlaced signal.
- When interlaced signals are connected, flicker may occur on the projected image.

# Specifications

<b>Power supply</b>		For North America: 120 V ~ (120 V alternating current), 50 Hz/60 Hz For other countries: 100 V - 240 V ~ (100 V - 240 V alternating current), 50 Hz/60 Hz		
<b>Power consumption</b>	<b>Projecting</b>	For North America: 3.2 A, 320 W For other countries: 3.7 A-1.5 A, 320 W		
	<b>In standby mode</b>	When [STANDBY MODE] of [ECO MANAGEMENT] is set to [ECO] : 0.5 W *1 When [STANDBY MODE] of [ECO MANAGEMENT] is set to [NETWORK] : 1.6 W *2 When [STANDBY MODE] of [ECO MANAGEMENT] is set to [NORMAL] : 9.5 W When [STANDBY MODE] of [ECO MANAGEMENT] is set to [NORMAL], and [IN STANDBY MODE] of [AUDIO SETTING] is set to [ON] : 24 W		
<b>LCD panel</b>	<b>Panel size</b>	<b>PT-VW350</b>	1.5 cm (0.59") (aspect ratio 16 : 10)	
		<b>PT-VX420</b>	1.6 cm (0.63") (aspect ratio 4 : 3)	
	<b>Display method</b>	3 transparent LCD panels (RGB)		
	<b>Drive method</b>	Active matrix method		
	<b>Pixels</b>	<b>PT-VW350</b>	1 024 000 (1 280 x 800) x 3 panels	
<b>PT-VX420</b>		786 432 (1 024 x 768) x 3 panels		
<b>Lens</b>		Manual zoom : 1.6x Manual focus : F 1.6 to 1.9, f 15.31 mm to 24.64 mm		
<b>Luminous lamp</b>		240 W UHM lamp		
<b>Light output</b> *3	<b>PT-VW350</b>	4 000 lm		
	<b>PT-VX420</b>	4 500 lm		
<b>Contrast ratio</b> *3		12 000 : 1 (all white / all black) ([LAMP POWER] is set to [NORMAL], meanwhile [IRIS] is set to [ON])		
<b>Applicable scanning frequency</b> *4	<b>for Video signal (including S-video)</b>	Horizontal : 15.73 kHz, Vertical : 59.94 Hz Horizontal : 15.63 kHz, Vertical : 50 Hz		
	<b>for RGB signal</b>	Horizontal 15 kHz to 100 kHz, Vertical 24 Hz to 100 Hz Dot clock frequency: 162 MHz or less		
	<b>for YP<sub>B</sub>P<sub>R</sub> signal</b>	[525i(480i)]	Horizontal 15.73 kHz, Vertical 59.94 Hz	
		[625i(576i)]	Horizontal 15.63 kHz, Vertical 50 Hz	
		[525p(480p)]	Horizontal 31.47 kHz, Vertical 59.94 Hz	
[625p(576p)]		Horizontal 31.25 kHz, Vertical 50 Hz		
[750(720)/60p]		Horizontal 45.00 kHz, Vertical 60 Hz		
[750(720)/50p]		Horizontal 37.50 kHz, Vertical 50 Hz		
[1125(1080)/60i]		Horizontal 33.75 kHz, Vertical 60 Hz		
[1125(1080)/50i]		Horizontal 28.13 kHz, Vertical 50 Hz		
[1125(1080)/60p]		Horizontal 67.50 kHz, Vertical 60 Hz		
[1125(1080)/50p]		Horizontal 56.25 kHz, Vertical 50 Hz		
[1125(1080)/24p]	Horizontal 27.00 kHz, Vertical 24 Hz			
[1125(1080)/24sF]	Horizontal 27.00 kHz, Vertical 48 Hz			
[1125(1080)/25p]	Horizontal 28.13 kHz, Vertical 25 Hz			
[1125(1080)/30p]	Horizontal 33.75 kHz, Vertical 30 Hz			
<b>for HDMI signal</b>	525i(480i)*5, 625i(576i)*5, 525p(480p), 625p(576p), 750(720)/60p, 750(720)/50p, 1125(1080)/24p, 1125(1080)/24sF, 1125(1080)/25p, 1125(1080)/30p, 1125(1080)/60p, 1125(1080)/50p, 1125(1080)/60i, 1125(1080)/50i Displayable resolution: VGA to WUXGA (non-interlace) Dot clock frequency: up to 162 MHz			
<b>Color system</b>		7 (NTSC, NTSC4.43, PAL, PAL-N, PAL-M, SECAM, PAL60)		

\*1 When the [PROJECTOR SETUP] menu → [ECO MANAGEMENT] → [STANDBY MODE] is set to [ECO], the network function cannot be used in standby mode.

\*2 When the [PROJECTOR SETUP] menu → [ECO MANAGEMENT] → [STANDBY MODE] is set to [NETWORK], only the Wake on LAN function can be used in standby mode via wired LAN.

\*3 Measurement, measuring conditions and method of notation all comply with ISO21118 international standards.

\*4 For details of video signals that can be projected using this projector, refer to "List of compatible signals".  
(➡ page 112)

\*5 Pixel-Repetition signal (dot clock frequency 27.0 MHz) only

## Chapter 6 Appendix - Specifications

<b>Projection size</b>		0.76 m -7.62 m (30"-300")
<b>Screen aspect ratio</b>		<b>PT-VW350</b> 16 : 10
		<b>PT-VX420</b> 4 : 3
<b>Projection scheme</b>		[FRONT/DESK], [FRONT/CEILING], [REAR/DESK], [REAR/CEILING] (Menu setting system)
<b>Speaker</b>		1 (4.0 cm round-type)
<b>Maximum usable volume output</b>		10 W
<b>Terminals</b>	<b>&lt;COMPUTER 1 IN&gt;</b>	1 (High-density D-sub 15 pin female) [RGB signal] 0.7 V [p-p] 75 Ω (When G-SYNC: 1.0 V [p-p] 75 Ω) HD/SYNC TTL high impedance, automatic positive/negative polarity compatible VD TTL high impedance, automatic positive/negative polarity compatible (SYNC/HD and VD do not support 3 value SYNC.) [Y <sub>B</sub> P <sub>R</sub> signal] Y: 1.0 V [p-p] including synchronization signal, P <sub>B</sub> P <sub>R</sub> : 0.7 V [p-p] 75 Ω
	<b>&lt;COMPUTER 2 IN/1 OUT&gt;</b>	1 (High-density D-sub 15 pin female) [RGB signal] 0.7 V [p-p] 75 Ω (When G-SYNC: 1.0 V [p-p] 75 Ω) HD/SYNC TTL high impedance, automatic positive/negative polarity compatible VD TTL high impedance, automatic positive/negative polarity compatible (SYNC/HD and VD do not support 3 value SYNC.)
	<b>&lt;VIDEO IN&gt;</b>	1 (Pin jack 1.0 V [p-p] 75 Ω)
	<b>&lt;S-VIDEO IN&gt;</b>	1 (Mini DIN 4 pin, Y 1.0 V [p-p], C 0.286 V [p-p] 75 Ω, S1 signal compatible)
	<b>&lt;HDMI IN&gt;</b>	1 (HDMI 19 pin, HDCP and Deep color compatible) Audio signals: Linear PCM (Sampling frequency: 48 kHz/44.1 kHz/32 kHz)
	<b>&lt;AUDIO IN&gt;</b>	2 (M3 stereo mini jack, 0.5 V [rms], input impedance 22 kΩ and more) (<AUDIO IN 2 (MIC IN)> terminal support MIC input) 1 (Pin jack x 2 (L-R), 0.5 V [rms], input impedance 22 kΩ and more)
	<b>&lt;VARIABLE AUDIO OUT&gt;</b>	1 (M3 stereo mini jack, stereo monitor output compatible, 0 V [rms] to 2.0 V [rms] variable, output impedance 2.2 kΩ and less)
	<b>&lt;SERIAL IN&gt;</b>	1 (D-sub 9 pin, RS-232C compliant, for computer control use)
	<b>&lt;LAN&gt;</b>	1 (for RJ-45 network connection, PLink compatible, 10Base-T/100Base-TX)
<b>Power cable length</b>		2.0 m (78-3/4")
<b>Cabinet</b>		Molded plastic
<b>Dimensions</b>		Width: 352 mm (13-27/32") Height: 98 mm (3-27/32") (when the adjustable feet shortened) Depth: 279.4 mm (11")
<b>Weight</b>		Approx. 3.3 kg (7.28 lbs.) *6
<b>Noise level *3</b>		When set to [NORMAL] in [LAMP POWER] : 37 dB When set to [ECO] in [LAMP POWER] : 29 dB
<b>Operating environment</b>		Operating environment temperature *7: 0 °C (32 °F) to 40 °C (104 °F) (Elevation: below 1 400 m (4 593'); [HIGH ALTITUDE MODE]: [OFF]) 0 °C (32 °F) to 30 °C (86 °F) (Elevation: 1 400 m (4 593') ~ 2 000 m (6 562').; [HIGH ALTITUDE MODE]: [HIGH1]) 0 °C (32 °F) to 30 °C (86 °F) (Elevation: 2 000 m (6 562') ~ 2 700 m (8 858'); [HIGH ALTITUDE MODE]: [HIGH2]) Operating environment humidity: 20 % to 80 % (no condensation)
<b>Remote control</b>	<b>Power supply</b>	DC 3 V (battery (AAA/R03 or AAA/LR03 Type ) x 2)
	<b>Operating range</b>	Approx. 7 m (22'11-5/8") (when operated directly in front of receptor)
	<b>Weight</b>	63 g (2.22 ozs.) (including batteries)
	<b>Dimensions</b>	Width : 44 mm (1-23/32"), Length : 105 mm (4-1/8"), Height : 20.5 mm (13/16")

\*6 This is an average value. It may differ depending on individual product.

\*7 [LAMP POWER] will be switched to [ECO] automatically when the operating environment temperature is 35 °C to 40 °C.

### Note

- The part numbers of accessories and separately sold components are subject to change without notice.

# Dimensions

<Unit : mm (inch)>

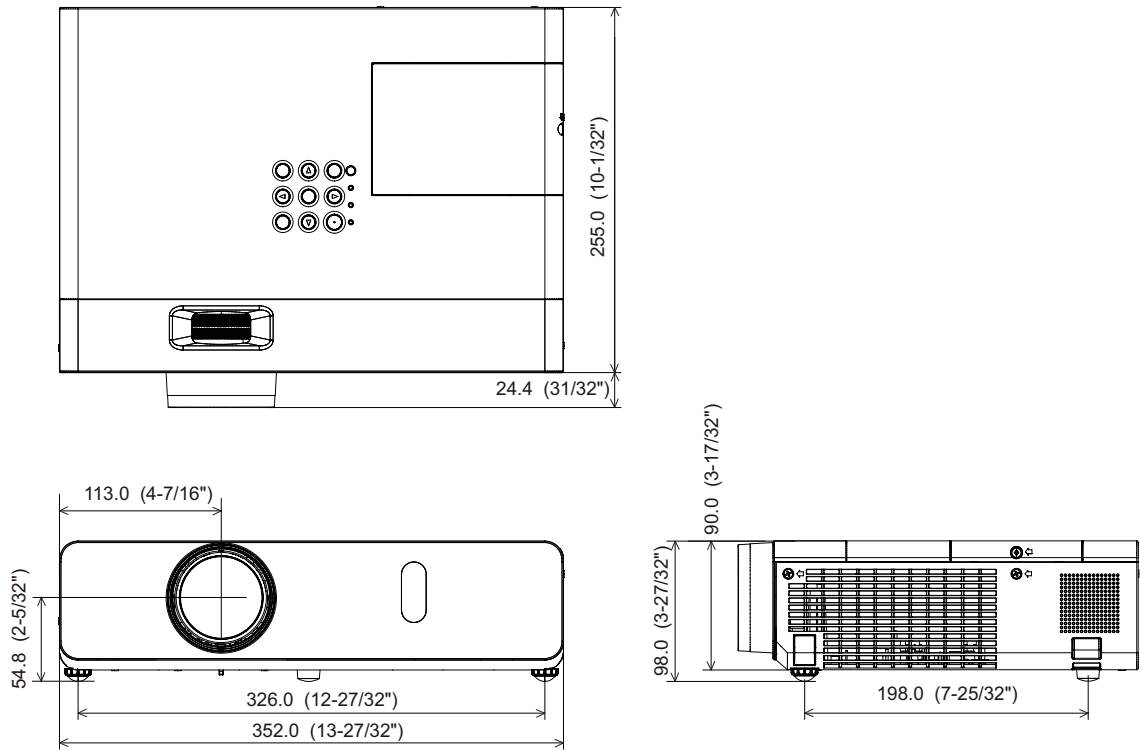

\* Actual dimension may differ by product.

# Ceiling mount bracket safeguards

- When installing the projector to a ceiling, be sure to use the specified optional Ceiling Mount Bracket for Projectors.  
Model No. of ceiling mount bracket:
  - ① ET-PKL100H (for high ceilings), ET-PKV400B (Projector Mount Bracket)
  - ② ET-PKL100S (for low ceilings), ET-PKV400B (Projector Mount Bracket)
- When installing the projector, attach the drop-prevention kit included with the Ceiling Mount Bracket for Projectors.
- Ask a qualified technician to do the installation work such as mounting the projector on the ceiling.
- Panasonic takes no responsibility for any damage to the projector resulting from use of a ceiling mount bracket not manufactured by Panasonic or the inappropriate choice of location for installation, even if the warranty period of the projector has not expired.
- Unused products must be removed promptly by a qualified technician.
- Use a torque screwdriver or Allen torque wrench to tighten bolts to their specified tightening torques. Do not use electric screwdrivers or impact screwdrivers.
- Read the Installation Instructions for the Ceiling Mount Bracket for Projectors for details.
- The model numbers of accessories and optional accessories are subject to change without prior notice.

## Bottom view

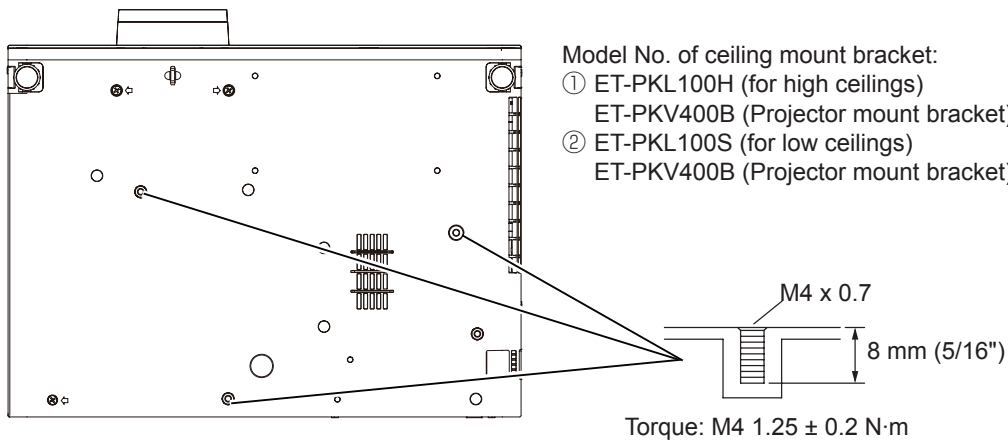

# Index

- A**
- Accessing from the Web browser ..... 83
  - Accessories ..... 17
  - <AC IN> terminal ..... 20
  - Adjusting adjustable feet ..... 29
  - [ADVANCED MENU] ..... 53
  - [AMX D.D.] ..... 80
  - [ASPECT] ..... 59
  - Attaching the Lens Cap ..... 24
  - [AUDIO SETTING] ..... 73
  - <AUTO SETUP> button
    - Projector body ..... 21
    - Remote control ..... 19, 41
  - [AUTO SETUP SETTING] ..... 65
  - <AV MUTE> button
    - Remote control ..... 19
- B**
- [BACK COLOR] ..... 65
  - Basic operations by using the remote control ..... 41
  - [BRIGHTNESS] ..... 52
- C**
- CD-ROM ..... 18
  - Ceiling mount bracket safeguards ..... 117
  - [CLOCK PHASE] ..... 58
  - [CLOSED CAPTION SETTING] ..... 63
  - [COLOR] ..... 52
  - [COLOR TEMPERATURE] ..... 53
  - <COMPUTER 1> button
    - Remote control ..... 19, 42
  - <COMPUTER 2> button
    - Remote control ..... 19, 42
  - [COMPUTER 2 SELECT] ..... 69
  - Connecting ..... 30
  - Connecting the power cord ..... 35
  - [CONTRAST] ..... 51
  - [CONTROL DEVICE SETUP] ..... 78
  - [Crestron Connected(TM)] ..... 80
- D**
- [DAYLIGHT VIEW] ..... 53
  - <DEFAULT> button
    - Remote control ..... 19, 48
  - Dimensions ..... 116
  - [DISPLAY OPTION] ..... 62
  - [DOT CLOCK] ..... 58
  - <D.ZOOM +/-> buttons
    - Remote control ..... 19, 43
- E**
- [ECO MANAGEMENT] ..... 71
  - [EMULATE] ..... 72
  - <ENTER> button
    - Projector body ..... 21
    - Remote control ..... 19
- F**
- [FILTER COUNTER] ..... 75
  - [FRAME LOCK] ..... 60
  - <FREEZE> button
    - Remote control ..... 19, 42
  - <FUNCTION> button
    - Remote control ..... 19, 42
  - [FUNCTION BUTTON] ..... 73
- H**
- <HDMI> button
    - Remote control ..... 19, 42
  - [HDMI SIGNAL LEVEL] ..... 63
  - [HIGH ALTITUDE MODE] ..... 70
- I**
- <ID ALL> button
    - Remote control ..... 19, 45
  - <ID SET> button
    - Remote control ..... 19, 45
  - [INITIALIZE] ..... 81
  - [INITIALIZE ALL] ..... 75
  - [INITIAL START UP] ..... 70
  - <INPUT SELECT> button
    - Projector body ..... 21
  - Installation mode ..... 26
  - [IRIS] ..... 53
- K**
- [KEystone] ..... 56
  - <KEYSTONE> button
    - Remote control ..... 19, 41
- L**
- Lamp indicator ..... 21, 98
  - [LAMP POWER] ..... 71
  - [LANGUAGE] ..... 61
  - List of compatible signals ..... 112
- M**
- Main menu ..... 48
  - Maintenance/replacement ..... 99
  - <MENU> button
    - Projector body ..... 21
    - Remote control ..... 19
  - [MENU LOCK] ..... 77
  - [MENU LOCK PASSWORD] ..... 77
  - Menu Navigation ..... 47
  - <MUTE> button
    - Remote control ..... 19, 44
- N**
- [NAME CHANGE] ..... 80
  - [NETWORK] ..... 79
  - Network connections ..... 81
  - [NETWORK CONTROL] ..... 80
  - [NOISE REDUCTION] ..... 54
- O**
- [ON-SCREEN DISPLAY] ..... 62
  - Optional accessories ..... 18
  - [OTHER FUNCTIONS] ..... 67
  - [OVER SCAN] ..... 59
- P**
- [PASSWORD] ..... 76
  - [PASSWORD CHANGE] ..... 76
  - [PICTURE] ..... 51
  - [PICTURE MODE] ..... 51
  - [P IN P] ..... 67
  - <P IN P> button
    - Remote control ..... 19, 45
  - PJLink protocol ..... 105
  - [POSITION] ..... 56
  - Power button
    - Projector body ..... 21
    - Remote control ..... 19
  - Powering Off the Projector ..... 39
  - Powering On the Projector ..... 36
  - Precautions for use ..... 14
  - Projecting ..... 40
  - [PROJECTION METHOD] ..... 70
  - [PROJECTOR ID] ..... 69
  - [PROJECTOR SETUP] ..... 69
  - [P-TIMER] ..... 66
  - <P-TIMER> button
    - Remote control ..... 19, 43
- R**
- Read this first! ..... 2
  - [REALTIME KEYSTONE] ..... 56
  - Remote control ..... 19
  - <RETURN> button
    - Remote control ..... 19, 48
  - [RGB/YPbPr]/[RGB/YCbCr] ..... 55
- S**
- [SCREEN SETTING] ..... 64
  - [SECURITY] ..... 76
  - Setting up ..... 26
  - [SHARPNESS] ..... 52
  - [SHIFT] ..... 58
  - [SIGNAL SEARCH] ..... 65
  - Specifications ..... 114
  - [STARTUP LOGO] ..... 64
  - [STATUS] ..... 69, 81
  - Sub-menu ..... 49
  - <S-VIDEO> button
    - Remote control ..... 19, 42
  - [SXGA MODE] ..... 65
- T**
- [TEST PATTERN] ..... 75
  - [TEXT CHANGE] ..... 77
  - [TEXT DISPLAY] ..... 77
  - [TINT] ..... 52
  - Troubleshooting ..... 103
  - [TV-SYSTEM] ..... 54
  - Two window display combination list ..... 111
- V**
- <VIDEO> button
    - Remote control ..... 19, 42
- W**
- [WIDE MODE] ..... 65
  - [WIRED LAN] ..... 79

## Information for Users on Collection and Disposal of Old Equipment and used Batteries



These symbols on the products, packaging, and/or accompanying documents mean that used electrical and electronic products and batteries should not be mixed with general household waste. For proper treatment, recovery and recycling of old products and used batteries, please take them to applicable collection points, in accordance with your national legislation and the Directives 2002/96/EC and 2006/66/EC.

By disposing of these products and batteries correctly, you will help to save valuable resources and prevent any potential negative effects on human health and the environment which could otherwise arise from inappropriate waste handling.



For more information about collection and recycling of old products and batteries, please contact your local municipality, your waste disposal service or the point of sale where you purchased the items.

Penalties may be applicable for incorrect disposal of this waste, in accordance with national legislation.



### For business users in the European Union

If you wish to discard electrical and electronic equipment, please contact your dealer or supplier for further information.

Cd

### Information on Disposal in other Countries outside the European Union

These symbols are only valid in the European Union. If you wish to discard these items, please contact your local authorities or dealer and ask for the correct method of disposal.

### Note for the battery symbol (bottom two symbol examples):

This symbol might be used in combination with a chemical symbol. In this case it complies with the requirement set by the Directive for the chemical involved.

## Product information (for Turkey only)

AEEE Yönetmeliğine Uygundur.

Eski Ekipman ve Bataryaların İşlenmesi.

Sadece geri dönüşüm sistemleri olan Avrupa Birliği ve ülkeleri için geçerlidir.



Ürünler, ambalaj ve/veya ekli belgeler üzerindeki bu semboller kullanılmış elektrik ve elektronik ürünlerin ve pillerin genel ev atığı ile karıştırılmaması gerektiğini ifade eder.  
Eski ürünlerin ve pillerin toplanması ve geri kazanılması için bu atıkları lütfen yasayla belirlenmiş olan uygun toplama merkezlerine teslim ediniz.

Bu atıkların doğru işlenmesiyle, değerli kaynakların korunmasına ve insan sağlığı ve çevreye olası negatif etkilerinin engellenmesine yardımcı olabilirsiniz.

Atıkların toplanması ve geri dönüşümü için detaylı bilgi için lütfen bağlı olduğunuz yerel yönetimlerle iletişime geçiniz.

Atıkların atılmasıyla ilgili yanlış uygulamalar yasayla belirlenmiş olan cezalara sebebiyet verebilir.

# Panasonic Corporation

Web Site : <http://panasonic.net/avc/projector/>

© Panasonic Corporation 2015

## Panasonic Systems Communications Company of North America

5th Floor, Two Riverfront Plaza, Newark, NJ 07102-5490

TEL: (877) 803 - 8492

## Panasonic Canada Inc.

5770 Ambler Drive, Mississauga, Ontario L4W 2T3

TEL: (905) 624 - 5010

W0415HY0 -ST